



# 2020 South Dakota 4-H Horse Project Show Guide

Erin Thelander | SDSU Extension State 4-H Agri-Workforce Coordinator

## Table of Contents

<b>Classes</b> .....	<b>1</b>	Hand Set .....	12
<b>South Dakota 4-H</b> .....	<b>2</b>	Basic Riding Position .....	13
4-H Youth Development Program .....	2	Position in Motion .....	13
<b>General 4-H Rules</b> .....	<b>2</b>	Scoring & Penalties .....	14
Use of the 4-H Emblem & Name .....	2	Ranch Riding .....	14
Insurance .....	2	Stock Seat Equitation .....	16
Liability .....	2	Reining .....	16
Guidelines for Accommodations .....	3	Trail .....	18
South Dakota 4-H Code of Animal		Mandatory Obstacles .....	18
Show Ring Ethics .....	3	Optional Obstacles .....	19
Local Determinations .....	3	<b>English Performance &amp; Equitation</b> .....	<b>20</b>
Protest Procedure .....	3	Hunt Seat Equitation, Hunter Equitation Over	
Age Divisions for South Dakota 4-H Cloverbud &		Fences, & Pleasure Driving .....	20
4-H Youth 4-H .....	4	Hunt Seat Equitation .....	20
<b>South Dakota 4-H Horse Project</b> .....	<b>4</b>	Hunter Equitation Over Fences .....	22
Purpose & Objectives of the 4-H Horse Program .....	4	Pleasure Driving .....	23
Administration of Rules & Regulations .....	4	Gaits .....	24
4-H Youth Horse Training .....	4	Basic Driving Position .....	25
Horse Ownership .....	4	Class Conditions & Rules .....	25
Pony Measuring .....	5	Class Procedure .....	25
<b>4-H Horse Show Rules</b> .....	<b>5</b>	Judge's Suggested Scoring System .....	26
Behavior .....	5	<b>Timed Performance Events</b> .....	<b>26</b>
Safety .....	6	Barrel Racing .....	26
Entry .....	6	Class Routine .....	27
Stalling .....	6	Pattern Standards .....	27
Appearance .....	6	Pole Bending .....	27
Horse Show Judges .....	6	Class Routine .....	27
State Horse Show Qualification .....	7	Penalties .....	28
State Horse Show .....	7	Class Routine .....	28
State Fairgrounds .....	7	Pattern Standards .....	28
Certificate of Veterinary Inspection .....	8	Flag Race .....	28
Exhibitor Attire .....	8	Roping Events .....	29
State 4-H Horse Show Awards .....	9	Breakaway Roping .....	29
Award System .....	9	Penalties .....	30
<b>Showmanship</b> .....	<b>9</b>	Calf Roping .....	30
Showmanship Tack .....	9	Penalties .....	30
The Quarter System of Showmanship .....	10	Dally team Roping .....	31
Beginner & Junior Showmanship .....	11	Penalties .....	31
Senior Showmanship .....	11	Qualification/Partner .....	32
Draft Horse Showmanship .....	11	<b>Youth In Action</b> .....	<b>32</b>
Class Procedure .....	11	State 4-H Horse Youth In Action Awards .....	32
<b>Western Performance &amp; Equitation</b> .....	<b>12</b>	State 4-H Hippology Contest .....	33
Tack & Equipment .....	12	Examination Phase .....	33
Seat & Hands .....	12	Station Phase .....	33
		Judging Phase .....	33
		Team Problems Phase .....	33

Tie Breaking . . . . .	34
Resources . . . . .	34
State 4-H Horse Judging Contest . . . . .	34
Senior Contest . . . . .	34
Junior Contest . . . . .	34
Beginner Contest . . . . .	34
State 4-H Horse Quiz Bowl . . . . .	35
Questions . . . . .	36
Match Procedures . . . . .	36
Resources . . . . .	36
Scoring . . . . .	37
State 4-H Horse Public Speaking Contest . . . . .	37
State 4-H Horse Demonstration Contest . . . . .	38
<b>Appendix A . . . . .</b>	<b>40</b>
<b>Appendix B . . . . .</b>	<b>45</b>

## 2020 South Dakota 4-H Horse Project Show Guide

Erin Thelander | SDSU Extension State 4-H Agri-Workforce Coordinator

### Classes

The following will be the official classes at the State 4-H Horse Show. Contestants should enter classes within their age division whenever possible.

#### Showmanship

- Beginner Western Showmanship
- Junior Western Showmanship
- Senior Western Showmanship
- Beginner English Showmanship
- Junior English Showmanship
- Senior English Showmanship
- Junior Draft Horse Showmanship
- Senior Draft Horse Showmanship

#### Equitation

- Beginner Stock Seat Equitation
- Junior Stock Seat Equitation
- Senior Stock Seat Equitation
- Beginner Hunt Seat/Saddle Seat Equitation
- Junior Hunt Seat Equitation
- Senior Hunt Seat Equitation
- Junior Hunter Equitation Over Fences
- Senior Hunter Equitation Over Fences

#### Performance

- Junior Reining
- Senior Reining
- Junior Ranch Riding
- Senior Ranch Riding
- Beginner Trail
- Junior Trail
- Senior Trail
- Junior Pleasure Single Driving
  1. Pleasure-type horse (Arabians, Morgans, Saddlebreds, NSH)
  2. Stock-type horse (Paints, Quarter horses, Apps)
  3. Draft horse (Belgians, Percherons, Clydesdales, Shires, Mules, etc.)
  4. Ponies (Over 38" to 56" at the withers)
  5. Miniature horses (38" and under at the last mane hair)
- Senior Pleasure Single Driving
  1. Pleasure-type horse (Arabians, Morgans, Saddlebreds, National Show Horses)
  2. Stock-type horse (Paints, Quarter horses, Appaloosas)
  3. Draft horse (Belgians, Percherons, Clydesdales, Shires, Mules, etc.)

4. Ponies (Over 38" to 56" at the withers)
  5. Miniature horses (38" and under at the last mane hair)
- Junior Team Hitch Driving
    1. Miniature or Pony team
    2. Horse team
    3. Draft team
  - Senior Team Hitch Driving
    1. Miniature or Pony team
    2. Horse team
    3. Draft team

#### **Timed Events**

- Junior Barrel Racing
- Junior Pony Barrel Racing
- Senior Barrel Racing
- Junior Pole Bending
- Junior Pony Pole Bending
- Senior Pole Bending
- Beginner Flag Racing
- Beginner Pony Flag Racing
- Junior Break-Away Roping
- Senior Break-Away Roping
- Senior Tie-Down Calf Roping
- Senior Team Roping

Note: A senior contestant may compete with a pony in any senior division event. A senior contestant may compete with a miniature horse in western showmanship.

## **South Dakota 4-H**

### **4-H Youth Development Program**

South Dakota 4-H Mission Statement: South Dakota 4-H enables youth to be engaged in the following:

- Partnerships with caring adults
- Positive learning environments
- Developing their fullest potential
- Learning life skills

South Dakota 4-H Vision Statement: South Dakota 4-H empowers youth to become self-reliant, contributing, and productive members of society.

## **General 4-H Rules**

### **Use Of The 4-H Emblem & Name**

The use of the name and emblem of 4-H is regulated by federal law. This law states that only activities or programs under the supervision of SDSU Extension may use the name and emblem of 4-H. Shows or events sponsored by other organizations or individuals and shows that do not provide separate classes for 4-H members are not permitted to use the name and emblem.

### **Insurance**

All 4-H members must have on file in their County 4-H Office by May 31, of each year, a signed copy of the 4-H member insurance form. This document verifies the type of insurance coverage being provided for the 4-H member during the course of 4-H sponsored activities. Please check with your County 4-H Office regarding county requirements for health and accident insurance. No coverage will be provided at the State level. The South Dakota State Fair Commission and the 4-H Youth Development Program do not provide livestock or other exhibit insurance. Exhibitors are responsible for their own livestock or display exhibit insurance should they desire to carry coverage.

### **Liability**

The South Dakota State Fair Commission and the 4-H Youth Development Program use diligence to ensure safety of exhibits after items arrive and are placed on display; but in no case are they responsible for any loss or damage done to, occasioned by, or arising from, any animal or article in the exhibition, and exhibitors shall indemnify the South Dakota State Fair

Commission and the 4-H Youth Development Program against all legal or other proceedings in regard thereto. Exhibitors are cautioned to exercise great care before deciding to exhibit family heirlooms and/or other highly valuable items.

### **Guidelines for Accommodations**

The South Dakota 4-H Youth Development Program should be accessible to the wide diversity of youth who live in our state, regardless of their backgrounds and characteristics — including physical, mental or emotional abilities or limitations. The primary purpose of 4-H is to provide all youth with the opportunity to grow and develop while maximizing their inner potential. We accomplish this objective by providing hands-on educational experiences using the knowledge base of SDSU Extension, other land-grant universities, and the United State Department of Agriculture. 4-H conducts “hands-on experiences” as the venue in which youth learn. Ideally, children with disabilities should be able to participate in the activities with their peers and any necessary accommodations should be made to make that possible. Any accommodation for child with a disability should:

- Allow a youth member with a disability to participate in the same collective activity as all other youth at the same age level. Observation of the activity without direct involvement does not constitute participation.
- Not adversely affect how other participants in the activity perform or are evaluated. Every effort should be made to minimize the effects of the accommodation on other participants.
- Be assessed on a case-by-case basis. The assessment of accommodations should include the child, the child’s parents, leader of the activity and a 4-H program representative (such as a 4-H Youth Program Advisor or a 4-H Field Specialist). Consultation with vocational rehabilitation professionals or professionals who teach or provide services to the youth with the disability is recommended to determine appropriate and reasonable accommodations. Contact the State 4-H Office to request these services.
- Be reasonable. Accommodations are considered reasonable if they do not change the fundamental nature of the program or alter the essential criteria for participation. If an accommodation does not alter the fundamental nature of the program, then it is reasonable and will be provided. Youth with disabilities will be judged using the same criteria as other participants. The accommodation should allow them to participate in the activity and achieve the criteria while not counting against the final determination of success.

Examples of possible accommodations include modifying rules, policies or timing of events; eliminating architectural barriers; providing interpreters; modifying equipment; providing additional spacing needs; providing verbal or modified testing; allowing the use of technology (e.g. letter boards, computer); or other types of accommodations as needed.

It is important to respect the privacy of the individual 4-H participant. Information regarding a youth’s personal situation or disability is confidential. Any information that is gathered in order to assist the child with full participation must be used for that purpose only.

### **South Dakota 4-H Code of Animal Show Ring Ethics**

South Dakota 4-H endorses and supports the International Association of Fairs and Expositions (IAFE) National Code of Show Ring Ethics. All exhibitors and their families agree to abide by this Code of Ethics and all rules and regulations printed in this rule book. Each exhibitor and their family are responsible for becoming familiar with those sections of the rule book that pertain to the area of their competition and abide by those rules at all times. The objectives listed within the Code of Ethics shall encourage all exhibitors and their families to maintain a high standard of ethics while competing at the South Dakota State 4-H Horse Show. Violation of rules will lead to penalties for exhibitors and their families which may include disqualification, barring from future shows, and removal of awards. It is further consented and understood that any action in violation of these rules that also violates federal/state/provincial status, regulations or rules may be released to appropriate law enforcement authorities with jurisdiction over such infractions.

### **Local Determinations**

The 4-H Youth Program Advisor, State 4-H Office, current county committee and/or program leader are responsible for initial rule interpretations and decisions. An individual should first notify the appropriate Area Chair of the grievance of a decision, protest of a rule, or policy infraction within seven (7) calendar days of notice of the incident. If the concern is not satisfied by local initial action or non-action within seven (7) calendar days of notification to the local decision maker, a written request is needed to initiate a formal protest or grievance.

### **Protest Procedure**

In accordance with the South Dakota 4-H Youth Development Program Interim Protest and Grievance and Policies document, protests at the State 4-H Horse Show will follow the policies and procedures found in the official SDSU Extension Civil Rights Plan document on <https://extension.sdstate.edu/>. This policy is applicable to any protest or grievance related to application of 4-H rules, including by way of example but not exclusion, to State 4-H Horse Show protest and 4-H Code

of Conduct violation allegations. This policy is not applicable to challenge judges' integrity, decisions, placements or other evaluations absent a rule violation.

The respective Show Chair has the authority to make appropriate decisions based on the current South Dakota 4-H Horse Project Show Guide. To allow for smooth operation of events, affected exhibitors may be allowed to participate in the event with the results subject to change based on the outcome of the Protest Procedure. 4-H Administration reserves the right to exclude exhibitors if warranted and withhold any awards in accordance with the Interim Protest and Grievance and Policies.

#### Age Divisions for South Dakota 4-H Cloverbud & 4-H Youth 4-H

4-H Age Division	Age on or before January 1 of the current 4-H program year
Cloverbud	Age 5, 6 or 7
Beginner	Age 8, 9, or 10
Junior	Age 11, 12, or 13
Senior	Age 14, 15, 16, 17, or 18

- Youth with special needs/disabilities are eligible to enroll. The County 4-H Office must notify the State 4-H Office in order to waive the age requirement.
- Beginners are to enter junior classes if there is not a Beginner class listed.

### South Dakota 4-H Horse Project

#### Purpose & Objectives of the 4-H Horse Program

Help the 4-H member:

- Develop leadership, initiative, self-reliance, sportsmanship and other desirable traits of character.
- Experience the pride and responsibility of having an equine and learning about its care, feeding, management, and related costs.
- Appreciate horseback riding as a healthy and wholesome form of recreation.
- Gain skill in horsemanship, patience and understanding when humanely handling horses and ponies along with nurturing a greater love for animals.
- Acknowledge safety precautions to prevent injuries to themselves, others, and horses.
- Prepare for citizenship responsibilities by working together in groups and supporting community horse projects and activities.

#### Administration of Rules & Regulations

This rule book establishes uniform regulations and procedures for qualifying and participating in the South Dakota State 4-H Horse Show. The rules govern the state show, the county shows and all shows used to qualify contestants for the state show.

Classes that fit the majority of South Dakota 4-H members are offered at the State 4-H Horse Show. Local and county shows may include other classes where necessary. The South Dakota State 4-H Horse Show should be a positive environment for those who participate.

The 4-H Youth Development Program reserves to its Executive Committee and Staff the final and absolute right to interpret these rules and regulations and to arbitrarily settle and determine all matters, questions and differences in regard thereto, or otherwise arising out of or connected with or incident to the Show, and the right to amend or add to these rules as its judgment may determine.

#### 4-H Youth Horse Training

The Youth Horse Ownership Responsibility Safety & Education Training program is designed to teach youth enrolled in the horse project important components of horse safety and care through hands on training activities and interactive presentations administered by a Youth HORSE Trainer following guidelines outlined in the Youth HORSE Training Program.

All 4-H youth enrolled in the Horse Project including those competing in Youth in Action events only are required to complete the Youth HORSE Training annually. The training must be completed by June 1 of each year. For more information, please refer to the Youth HORSE Training Program material or your local 4-H Youth Program Advisor.

#### Horse Ownership

References to horses throughout this project show guide mean all equine animals.

Horses of any breed or breed combination are acceptable for this project. Mares and geldings may be of any age. Stallions over 8 months of age may not be exhibited. Horses shall be serviceably sound and in good condition.

1. Any horse to be used by a member in the Horse Project is to be filed on Horse Form in their county by June 1st of each year. A member may register as many horses as they wish, however, only three horses may be used for qualification for and during the State 4-H Horse Show. A driving team will count as one horse for entry purposes. Except in cases of emergency or extenuating circumstances, the horse used in a qualifying competition must be used in the same event at the State 4-H Horse Show.
2. Members must have managing control of their horse project. "Managing control" means overseeing proper feeding, grooming, exercising, training and stall management, and the member must have free access to the use of the horse at all times.
  - a. A 4-H member enrolled in the 4-H Horsemanship project must have managing control of the horse by June 1. The horse may be owned solely by the 4-H exhibitor, or the exhibitor in partnership with other family member(s) of his or her immediate family, or leased for use as a 4-H project. If the horse is not owned, the legal owner must provide a written statement guaranteeing that the 4-H member has managing control of the animal by June 1. This statement is kept on file in the county Extension office in the county of enrollment.
  - b. In an emergency or extenuating circumstance, members who qualify for State 4-H Horse Show may exhibit any horse listed on the member's Horse Form during the current 4-H year. Requests to substitute a horse must be submitted to the County office by the appropriate show deadline and approved by the County 4-H Youth Program Advisor.
  - c. In cases of emergency or extenuating circumstance, two members of a family may share a family-owned horse. These members would have to exhibit this animal in different classes at the County/State 4-H Horse Show. A horse may not be shown more than once in the same class regardless of age division. Example: A horse may not be exhibited in both Beginner Western Showmanship and Senior Western Showmanship. However, that horse could be exhibited in a Western Showmanship class and an English Showmanship class.

Injured horses and hardship cases: Prior to the event, the State 4-H Office will handle horse substitutions on a case-by-case basis. The 4-H member must contact his/her County 4-H Youth Development Advisor who will communicate the request to the 4-H Livestock Show Management Coordinator. Cases of hardship prior to County Horse Shows according to the hardship rule will be left to the county horse committee. However, in most cases, documentation from a veterinarian is needed to prove the horse is unable to compete at both County and State events.

### **Pony Measuring**

All ponies will be measured at the State 4-H Horse Show with an approved pony measurement stick. Ponies must be measured on a level surface. A concrete slab or other paved surface is more desirable but when not available, a heavy sheet of plywood can be used. The measurements will be submitted with the State 4-H Horse Show entries.

The pony must stand squarely on all four feet in such a position that the front legs are vertical to the ground and the back of the hocks are in a vertical line with the point of the hindquarters. The head must be held low enough to reveal the highest point of the withers and no lower. With the pony in that position, the vertical height is measured from the highest point of the withers to the ground.

1. Ponies (Over 38" to 56" at the withers)
2. Miniature horses (38" and under at the last mane hair)

## **4-H Horse Show Rules**

All Horse Show exhibitors must abide by the South Dakota 4-H Code of Animal Show Ring Ethics and show rules listed in the South Dakota 4-H Horse Project Show Guide.

### **Behavior**

1. All rules and guidelines, as stated in the 4-H Horse Project Show Guide, are the official rules for the County and State 4-H Horse Shows.
2. To be eligible for participation in any 4-H Horse Show, the 4-H member must be enrolled in the 4-H Horse Project.
3. Contestants are expected to be courteous, friendly and sportsmanlike at all times.
4. Adults are to conduct themselves in a manner that reflects a positive model for 4-H youth at all times.
5. Violations of acceptable conduct will be dealt with by the show management and may result in disqualification from an event(s), awards or from the show. At any time, people behaving in an inappropriate manner may be asked to leave the show.
6. Show management may expel any person or persons abusing a horse from the grounds at any time. Entry fees and awards will be forfeited.



7. At no time should the contestants and /or parents confront the judge before or during the show. Contestants and /or parents may be allowed to contact the judge following the show at the discretion of show management. If contact with the judge is allowed, contestants and parents are to act in an appropriate manner.

### **Safety**

8. Safety must be emphasized at all times, both in and out of the ring. The safety of spectators, contestants and their mounts must be the shared responsibility of all involved in the show.
9. A contestant and his/her horse may be dismissed from the arena for undesirable conduct of either or both. A kicking horse is a safety hazard to other contestants, horses, and show officials.
10. A contestant using a lame or otherwise unsound horse may be excused from the arena at the judge's and/or horse committee's discretion.
11. No exhibitor may be tied, buckled, or fastened into the saddle in any manner or by any means during competition, except in timed events where one rubber band not over 1/4 inch may be used per foot.
12. Any physically or mentally challenged contestant must give adequate notification to the Extension staff before participating in the Horse Project so the proper considerations can be made.
13. Three refusals to enter the arena will result in disqualification in any event. A refusal is any step not going toward the ring (whether forward, sideways, or backwards). Any ring official—the judge, ring steward, or gate person, may call the disqualification.

### **Entry**

14. Only exhibitors and horses officially entered in the class will be allowed in the show ring while that class is being judged.
15. A fall of either horse or rider in the arena shall be cause for elimination from that class. A fall of the rider occurs when the rider is separated from his/her horse in such a manner as to require remounting. A horse is considered fallen when its shoulder touches the ground.
16. Each exhibitor will be limited to exhibiting three (3) horses. One must be shown by the 4-H member in a showmanship class at the county level. If multiple non-showmanship horses are to be shown, they must be inspected for proper grooming at the County level. Team Hitch Clarification: A team hitch will be treated as one horse and the member may show/ride in two other horse events. A 4-H member is limited to three horses at the State 4-H Horse Show, but a team is counted as one horse and one entry. 4-H members may show individual horses from a team that qualified at the county level in showmanship at halter.
17. Any exhibitor/horse combination may not show or be shown more than once in any class or any event regardless of age division. English and Western Showmanship are not considered the same class; therefore, the same horse can be shown once in each of the classes.  
\* Any exception considered for the State 4-H Horse show must be approved by the State 4-H Office prior to the event.

### **Stalling**

18. Stalls will be selected and paid for at the gate BEFORE the horse or competitor can enter the fairgrounds.

### **Appearance**

19. The use of artificial tail fans, artificial polls, false tails or the addition of any hair or hair-like substance to any part of the animal's body is prohibited.
20. The dress code for all events will be enforced.

### **Horse Show Judges**

21. Judges will use and follow all rules and guidelines as stated in the 4-H Horse Project Show Guide.
22. Reasons/General Critique will be given in every event following the awarding of Grand and Reserve Champion. This will allow youth to understand the criteria the youth were judged on and allow the judge an explanation of his/her placing.
23. Official judges will be asked to record the Grand and Reserve Champions and third through fifth place in each class and to sign a document making those placings official.
24. Judge's decisions are final.
25. Contestants may be disqualified for not following the judge's instructions.
26. The judge may excuse an exhibitor and horse from the class if lack of control compromises the safety of the horse(s) or exhibitor(s).
27. Inhumane treatment may result from over enthusiastic use of legal equipment. The judge may either caution the exhibitor and let him or her continue or excuse the horse and rider.
28. If a horse's mouth is bleeding during any performance class, the judge is to immediately excuse and temporarily disqualify the horse. The horse may qualify for future classes after the judge has received a written statement following examination from a licensed veterinarian that it is safe for the horse to continue. Further or increased exhibition of stress by the animal or continuance of blood flow will result in immediate disqualification from the show.

29. The judge has the final authority on equipment and its use in accordance with the rule book.
30. The judge may not change the requirement for equipment that clearly fits the intent of acceptable tack.
31. Judges may ban equipment that is questionable or any legal equipment that has been gimmicked and appears to have given unfair advantage to any contestant.
32. Judges and contestants should be aware that some legal equipment may be entirely too severe for certain timid horses and that the most severe legal equipment may provide only marginal control for others.
33. Under ordinary conditions, equipment should not break during the performance, nor should it be changed after the class starts, except on permission from the ringmaster or judge. The judge may disqualify an exhibitor for broken equipment.
34. Any and all obstacles in any class may be adorned at the judge's discretion.
35. The judge is the final authority related to handling of stock for roping events. If intentional rough handling is determined or if an exhibitor refuses to use legal equipment or uses altered legal equipment resulting in its failure, the exhibitor may be disqualified by the judge.

#### **State Horse Show Qualification**

36. Members are eligible to compete at the State 4-H Horse Show in any events in which they competed at their county horse show, regardless of ribbon placing. Members are required to use the same horse they qualified on within an event at their county show during the State 4-H Horse Show. Members cannot use a horse to qualify at the county show and then use a different horse in that event at the State 4-H Horse Show except in cases of emergency or extenuating circumstances.
37. Competitors are to participate in all available events in their own county. If a particular event is not offered and the contestant wishes to attempt to qualify for this event at a different county, this must first be approved by both the home and neighboring county.
38. A county may have more than one county 4-H horse show, if approved by the county committee. A contestant may only attempt to qualify for the state event at one show. The 4-H member must notify their County 4-H Office which show will be their qualifying show prior to competition in any show.
39. If a contestant is unable to attend his/her county's Horse Show, s/he may attempt to qualify for the State 4-H Horse Show in another county. This must be approved by both the home and neighboring county.
40. A lone team roper may compete with another team roper who has already competed, ONLY at the county level. This partner, however, must take the score received with the original partner, not the one acquired with the lone roper. The lone roper will be responsible for finding a partner for the State 4-H Horse Show.
41. Only Senior 4-H members are allowed to participate in Team Roping. A parent, adult volunteer/leader, or Junior 4-H member will not be allowed to participate. Violation of this rule will result in disqualification.
42. All State 4-H Horse Show entries and fees must be post marked by July 1st and sent to the State 4-H office.
43. Contestants will be required to pay a stock fee for roping events.

#### **State Horse Show**

44. Failure to comply with the State 4-H Horse Show rules and regulations can result in automatic expulsion from the show.
45. All protests or grievances at the State 4-H Horse Show must follow the protest procedure outlined by the SDSU Extension Civil Rights Plan.
46. Youth may enter as many classes and Youth in Action events as they qualified for at the county qualifying competition. The 4-H Horse Show Advisory Council and 4-H Staff will be unable to guarantee participation if scheduling conflicts occur. There will be no elective classes.

#### **State Fairgrounds**

47. No bicycles, scooters, or loose dogs allowed in the show arena areas during the State 4-H Horse Show. No dogs allowed in the arenas.
48. A limited number of horse stalling is available at the State 4-H Horse Show. Stalling is coordinated by State Fair Management and available on a first-serve limited basis at the time of gate entry check-in.
49. Tack stalls may be locked. Stalls with horses in them cannot be locked.
50. Wood chips are the only allowable bedding at the State 4-H Horse Show. Hay and wood chips may be available for purchase through the State Fair Management. All feed is the responsibility of the exhibitor. No straw allowed.
51. All cars, trucks, trailers, and campers will park in assigned areas. The State Fair Management Office assigns parking and camping areas.
52. All horses must be stabled and exercised in assigned areas. Horses are not allowed in all areas of the Fairgrounds.
53. 4-H exhibitors are expected to care for, groom, and ride their horses while at the State 4-H Horse Show. Only the 4-H member, a member of the immediate family, fellow 4-H member, or 4-H Club leader may perform the fitting, clipping, or riding on any horse at the State 4-H Horse Show. The 4-H exhibitor must be present while such work is being done with his/her horse.

54. There will be no riding or exercising of horses after 9:00 p.m. indoors and 10:00 p.m. in the outdoor arenas to ensure the safety of both horses and riders.
55. Youth must cooperate with show officials by supplying horses and/or exhibitors for performance classes for the State 4-H Horse Judging Contests. This rule is to ensure that we have high quality classes in the horse judging contest.

#### **Certificate of Veterinary Inspection**

56. All horses exhibited at the State 4-H Horse Show must be accompanied by a Certificate of Veterinary Inspection (CVI) issued by a licensed and accredited veterinarian within 30 days of entry to the State 4-H Horse Show and/or SD State Fair Open Class Horse Show. Any and all prescriptions are to be listed on the health papers.
57. All horses originating from outside the state of South Dakota must have a negative EIA test within the past twelve months prior to entry to the State 4-H Horse Show. The applicable testing information must appear on the Certificate of Veterinary Inspection.
58. All horses originating from outside the state of South Dakota must have a telephone permit number on the Certificate of Veterinary Inspection.
59. CVI must be presented as the horse(s) enter the State Fairgrounds. The entry superintendent will verify the CVI with the appropriate horse(s). Horses will not be allowed to be unloaded if they do not have a CVI.
60. Upon registration, State 4-H Horse Show Management will retain one copy of the CVI. Thus, it is suggested that each horse have a separate CVI to alleviate registration problems.
61. The health condition of the horse will be determined based on its condition upon State Fairgrounds entry. The entry committee or attending veterinarian reserve the right to conduct further examinations or tests on any horse for the purpose of determining the current health status of the animal and may request the removal of any horse(s) they feel may be endangering the health of other horses.

#### **Exhibitor Attire**

The standards of attire apply to all 4-H Horse Shows.

Properly worn ASTM/SEI approved headgear is strongly recommended for the exhibitors in any and all events and any time the rider is mounted.

Each exhibitor will be issued two identification numbers. The number is to be fastened on the back of the exhibitor, or on both sides of the saddle pad for riding classes so that it can be clearly seen by the judge. If the judge cannot read the number, the participant may be disqualified.

#### **Western Attire**

1. A long-sleeve white, button shirt or blouse with collar (t-shirts are not acceptable, tuxedo shirts are acceptable) No silver or metal decorations, pins, scarves, or other adornments allowed on exhibitor's shirt.
2. Plain dark blue western style denim jeans and belt
3. Western hat or any style of ASTM/SEI approved headgear. Caps are not allowed.
4. Western boots – Western style lace-up boots are acceptable. Riding tennis shoes are not allowed.
5. Chaps, vests, gloves and similar accessories are prohibited. Spurs are optional in performance events.

#### **English & Hunt Seat Attire**

1. Riders must wear boots, breeches, coat, and hunt cap
2. A hunt hardhat cap or ASTM/SEI approved headgear is acceptable. All colors are acceptable with preference for traditional conservative colors.
3. Coats should be any tweed or melton (conservative wash jackets in season) acceptable for hunting
4. High English boots or jodhpurs and jodhpur or paddock boots
5. Long or short sleeve shirts with ties or chokers are preferred. Choker pins are acceptable.
6. Gloves are optional.

#### **Driving Attire**

Pleasure Driving will follow Western attire rules.

Note: Pleasure Type Pleasure Driving will follow English attire rules.

1. Hats, neckties and gloves are acceptable and optional.
2. Chaps or spurs are illegal.
3. Exhibitors may wear rainwear or inclement weather apparel if conditions warrant.
4. Exhibitors must carry a whip in their hand or in a whip holder.

### Saddle Seat Attire

Formal or informal saddle suits are acceptable. Ties are required and gloves are optional, but preferred.

1. Informal— Conservative solid colors are preferred. Solid colors include: black, blue, gray, green, beige or brown with matching jodhpurs (white jacket in season) and derby or soft hat.
2. Formal—Solid colors are: dark gray, dark brown, dark blue or black tuxedo-type jacket with collar and lapels of the same color, top hat, jodhpurs to match and gloves or dark colored riding habit and accessories. All colors acceptable, but preference is for traditional, conservative colors.

### Timed Performance Events

Timed performance exhibitors are required to follow Western attire rules. Caps are not allowed. Note: Timed Performance Events contestants must wear a cowboy hat or helmet, long-sleeved shirt, western boots, and western pants in the arena at all times, whether competing or not, and must not roll up sleeves. Violators of this rule may be disqualified upon the discretion of the judges or the arena director.

### Youth in Action Attire

Western or English style dress for all events will be accepted.

### **State 4-H Horse Show Awards**

4-H members in 4-H horse riding and showmanship events are competing for awards provided by event sponsors and the South Dakota 4-H Youth Development Program. Awards may include but are not limited to: plaques, rosettes or ribbons. Top five exhibitors within each of the official South Dakota 4-H Horse Show Classes will be recognized at the State 4-H Horse Show. In addition, the top two exhibitors will receive grand and reserve champion awards.

### **Award System**

4-H members are awarded based on how well their performance compared to that of an ideal performance. The judge will place contestants in one of the four ribbon placing groups.

<b>Ribbon</b>	<b>Designation</b>
Purple	Superior - A performance that met all of the class requirements. Contained few, if any flaws. At the judge's discretion, top purples may be awarded for truly exceptional performances.
Blue	Excellent - A performance that met all of the class requirements. The performance contained few flaws and was well above minimum standards.
Red	Average - The performance was slightly above or at minimum standards. Although displaying good effort, the performance contained several flaws.
White	Room for Improvement - Performance was below minimum standards. The performance contained several flaws and considerable room for improvement exists or the exhibitor was disqualified.

## **Showmanship**

In 4-H Horse Projects, all breeds of ponies, light horses, mules, draft, or miniature horses may be used. Although 4-H has general standards, judges should recognize showmanship competence using the standards of the breed in hand. The class objective is to show the horse at its best advantage with the minimal attention drawn to the showman.

All age divisions will complete Showmanship classes using individual patterns. When the contestant's pattern is completed, he may exit the ring when asked to do so by the steward. Only Senior Showmanship classes may involve switches or changes of horses by participating youth at the judge's discretion.

### **Showmanship Tack**

Correct tack does not build points; however, incorrect tack can result in lower placings.

### Western

- Halter – may be leather, rope or nylon. Must be clean and adjusted to fit.
- Lead – should be six to seven feet long, neat and inconspicuous. The judge may penalize an exhibitor for excessive or abusive use of chain lead or for holding the chain portion of the lead with their hand.

### English

- Bridles – snaffle (without flash, crossed figure-8, or dropped nose-band), Pelhams, or full bridle.
- Lead – on full bridles: option to show off either snaffle or curb; on Pelhams: with four reins, options to show off either set, non-leading rein to be draped over withers in both situations.

### The Quarter System of Showmanship

The following suggested guidelines of movement are meant to serve as an illustration of proper movement around the horse while showing in Showmanship and are for exhibitor information.

Imaginary lines divide the horse into four equal parts as seen in the figure below. (Note: The horse has been section into four quadrants numbered I, II, III, and IV for ease of identification.) One line runs across the horse behind the withers. The other imaginary line runs from head to tail. When the judge is in I, the exhibitor should be in IV. As the judge moves to II, the exhibitor should move to I. When the judge moves to III, the exhibitor moves to IV. As the judges move up to IV, the exhibitor returns once more to I. This method is based on safety as the exhibitor can keep the horse's hindquarters from swinging toward the judge should the horse become fractious.

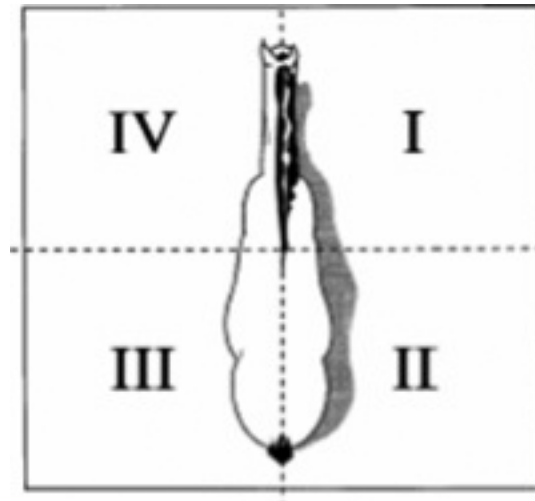

### Scoring & Penalties

<b>Judge's Suggested Scoring System – 100 points possible</b> <b>Applies to all Showmanship Classes</b>		
40 Points	Appearance of the Horse	Condition: 15 points
		Grooming: 25 points
50 Points	Showing of the Horse	Ring Deportment: 10 points
		Actions: 10 points
		Posing: 15 points
10 Points	The Exhibitor	Appearance: 10 points
		Attitude: 5 points

### Faults against Western & English Showmen

1. Failure to recognize and correct faults in the horse's position.
2. Visiting or conversing with other contestants in the arena while showing.
3. Kicking horse's leg into position.
4. Failure of the horse to lead properly.
5. Failure to stop before turning when showing at the walk or trot.
6. Failure to back horse when necessary.
7. Loud voice commands to the horse.
8. Over showing through unnecessary actions.
9. Blocking the judge's view of the horse.
10. Turning horse in the wrong direction.
11. Causing the judge to move to avoid being bumped or stepped on by the horse.
12. Improper fitting of equipment.
13. Improperly fitted or groomed horse.
14. Horse's feet not properly trimmed, shod or cleaned.

### Western & English Showmanship

Regardless of the pattern used, or where the judge works the pattern in the ring, the following principles apply:

- The exhibitor shall always lead the horse from the near (left) side.
- All turns shall be to the right, with the exhibitor walking to the right around the horse. The only exceptions being the initial lineup and when excused by the judge.

### Beginner & Junior Showmanship

Beginner & Junior exhibitors will use one of the patterns in the back of this book. The same pattern must be used for all exhibitors in the class. A different pattern may be used in a finals round.

### Senior Showmanship

The judge will select a pattern to be used for Western and English Senior Showmanship. The same pattern must be used for all exhibitors in the class. A different pattern may be used in a finals round.

### Draft Horse Showmanship

The horse should be presented in a thrifty, well-cared-for condition, neither thin nor excessively over weight. The animal should be clean. Tails may be natural or docked, braided or left long, but fit to the proportions of the horse. Manes may be rolled and decorated. Feet may be shod or unshod, but should be properly trimmed and clean. Black or natural hoof paint is acceptable. Halters and leads may be of leather, nylon or rope and should be clean and fitted to the horse. Show sticks and bridles will be allowed.

### Class Procedure

Horses will enter the ring at the trot and line up side-by-side at the direction of the ring steward.

Horses will be pulled from the line, walked to the judge or ring steward, walked to the opposite end of the arena (to the ring steward or judge), turned, and trotted back to the starting point. The turn at the far end of the arena should not be over the horse's hocks, but a slightly widened arc that results in the horse facing the opposite direction in line with the judge and ring steward when the turn is completed. The exhibitor should concentrate on keeping the horse on a straight path between the judge and ring steward for as long as possible but still leave room for the turn. Turns should always be away from the exhibitor when possible and/or feasible.

After showing your horse on the move, stop the horse and set the horse up. The quartering system is not used in Draft Horse Showmanship. Exhibitor should hold lead strap in right hand and show stick in left hand when leading the horse. When moving with the horse, its head should be even with the exhibitor's right shoulder. When setting up the horse, exhibitor should turn so the left shoulder is next to the horse. Change the lead to the left hand with show stick in right hand. When setting up and showing the horse, the lead should always be in the left hand. Return to the line after the judge excuses you. Horses should be shown with all four feet positioned correctly under the body while in line. The judge will closely inspect and may handle each horse. A trailer (person to assist with moving the horse) with or without a whip is permitted. The trailer should cross to the opposite side prior to the turn and should never get between the judge and the horse when the horse is in line but should stand behind the exhibitor some distance away and may assist in keeping the horse alert.

Deviations from this description may be necessary and will be announced prior to the beginning of the class. An alternate pattern is shown in Appendix B.

## Western Performance & Equitation

Stock Seat Equitation, Ranch Riding, Reining, and Trail Western Performance classes recognize the rider's ability to ride a horse correctly and to use various aids required for a horse to perform basic maneuvers. Riders will be judged on basic position in saddle; position and use of hands, legs and feet; ability to control and show the horse; and suitability of horse to rider. The rider's ability to execute maneuvers correctly shall be considered more important than the horse's performance. Grooming standards are consistent with showmanship.

### Tack & Equipment

Saddles - Must be sized to the rider and of western type.

#### Curb Bits

- Maximum shank length overall is 8½ inches. Shanks can be fixed or loose.
- Mouth pieces must have smooth, round bars or unwrapped metal, and measure between 3/8 and 3/4 inches in diameter when measured 1 inch from cheek. They may be inlaid but must be smooth or latex wrapped. Nothing may protrude below the mouthpiece (bars), such as extensions or prongs on solid mouthpiece. Mouthpiece may be 2 or 3 pieces. If 3 piece, a connection ring of 1¼ inch or less in diameter, or a connection flat bar of 3/8 to 3/4 inch (measured top to bottom with a maximum length of 2 inches), it must lie flat in horse's mouth.
- Ports may not exceed a maximum of 3 inches in height. Rollers (3/8 to 3/4 inch diameter) and covers are acceptable. Grazing, broken mouthpieces, half breeds, and spades are standard.

#### Snaffle Bits and Bosals

- May be used only for horses 5 years and younger
- Horses are to be shown in a true snaffle (conventional O-ring, egg butt or D-ring) or bosal. The bit must have a smooth broken mouthpiece. The mouthpiece must be at least 5/16 inch in diameter, measured 1 inch from the corner of the mouth piece. Curb straps are optional. When used, the straps must be loosely attached, meet the 4-H requirements and be attached below the reins.
- Bosals must be of braided leather, braided rawhide or rope. Absolutely no iron under the jaw, regardless of how padded or taped. Jaquimas are acceptable.
- Bits with gag action are illegal, except in speed and timed events.
- All mechanical hackamores are illegal except in speed events: (barrel racing, pole bending, roping).

#### Bit Curb chains and straps

- Curb chains and straps must be flat with a minimum width of one-half inch.
  - Round leather curb straps, braided knots, or flat braided curb straps are illegal.
  - Any twisted chain or strap is illegal.
- Legal curb straps are to be flat, wide chain or leather over ½ inch wide.
- Illegal: all raised and rough chains and leather less than ½ inch wide

Reins - Split reins or romal must be used. A romal may be used with closed-type reins. Romals must be of sufficient length to allow a minimum of 16 inches between the rein hand and the free hand holding the romal.

Riding Restraints - Running or standing martingales, tie-downs, nosebands, cavessons or draw reins are illegal except in speed and timed events (barrel racing, pole bending, flag race, roping).

Leg Wear - Horse leg wear is not allowed in Showmanship, Stock Seat, Saddle Seat, Hunt Seat, and Trail classes.

Please see Appendix A for visual examples of legal and illegal tack.

### Seat & Hands

Riders will be judged on seat, feet, hands, ability to control and show the horse, and suitability of the horse to the rider. Results shown by the performance of the horse are NOT considered more important than the method used by the rider to obtain them.

Hands - The hands must be free of the horse and saddle at all times the horse is in motion, unless it is necessary to use the hands to prevent a fall. The position of the rider's free hand is optional, but should portray a relaxed, balanced body situation and be kept free of the horse and equipment.

### Hand Set

- When using both hands on the reins of a snaffle bit or hackamore, the reins may or may not be crossed. The rider's hand should be carried near the pommel, and no further than 4 inches out on either side of the saddle horn. Rider's hands

must be steady with very limited movement.

- When split reins are used, one finger is permitted between reins.
- When using a romal, no finger is allowed between reins. Rider can hold romal with the hand not used for reining, provided it is held approximately sixteen inches from the reining hand.
- Two handing reins, a finger between romal reins, or more than one finger between split reins will result in a “no score” which is disqualification for all Western Performance classes. Holding Split Reins Holding romal Reins Acceptable Unacceptable Reins
- Reins should be held with the hand around the reins with one finger permitted between the reins. Reins may enter the hand under the little finger, up across the palm and out over the index finger or thumb. They may also enter over the index finger and down across the palm 24 and out below the little finger.
- Reins are to be used with one hand, and the rein hand must not be changed during the class, except when working the gate during the Trail class. EXCEPTION: Two hands may be used when using a ring snaffle or Bosal on horses five-years-old and younger, having qualified at the county level as such.
- Horses shall be shown on a reasonably loose rein. Extremes (too tight or too loose) shall be penalized. Dropping a rein that contacts the ground while the horse is in motion will result in a “no score” which is a disqualification for all Western Performance classes.

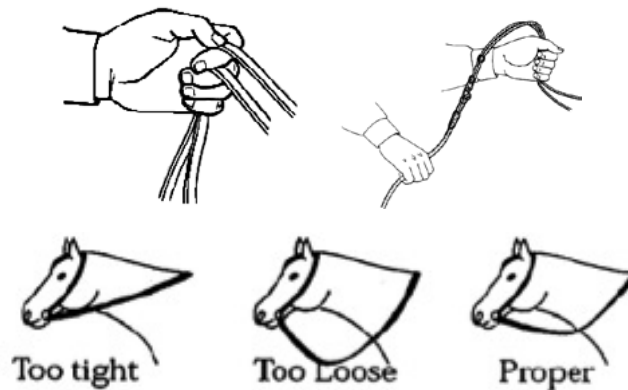

### Basic Riding Position

Rider should sit in the saddle with:

- Legs hanging straight and slightly forward of stirrups.
- Knees slightly bent and weight directly over balls of feet.
- In either position the stirrup should be short enough to allow the rider's heels to be lower than their toes.
- Body should always appear comfortable, relaxed and flexible.
- Feet should be placed in the stirrup with weight on ball of the foot. Consideration, however, should be given to the width of the stirrups, which varies. If stirrups are wide, the foot may have the appearance of being “home”, when in reality the weight is properly carried on the ball of the foot.

### Position in Motion

Rider should sit to trot/jog and not post. The rider should be close to the saddle at the lope. All movements of the horse should be governed by the use of imperceptible aids. Exaggerated shifting of the rider's weight is not desirable.

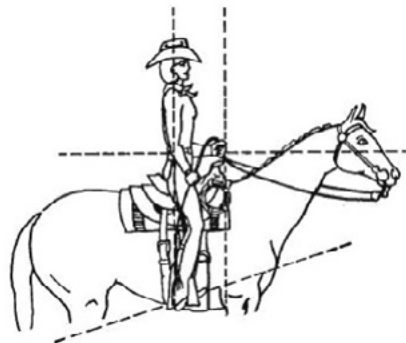



## Scoring & Penalties

The following are penalties which will result in a white ribbon placing in all Western Performance events:

- going off pattern or failure to complete the pattern as written
- taking four steps with the front legs in opposition of the pattern
- balking or refusal of command where pattern is delayed – a refusal is any step not moving in the appropriate direction
- running away or failing to guide where it becomes impossible to discern whether the entry is on pattern
- equipment failure that delays the completion of pattern
- dropping a rein that contacts the ground
- two-handing reins, a finger between romal reins, or more than one finger between split reins
- fall of either horse or rider
- knocking over markers
- rearing or other actions of horse which endanger horse and/or rider
- failure to have correct exhibitor number visible
- failure to wear appropriate western attire

The following are considered faults and should be judged accordingly:

- opening mouth excessively/head raising
- stumbling
- unnecessary aid given by the rider such as: jerking of reins, petting, spurring, unnecessary talking
- anticipating signal or early lead changes
- losing a stirrup
- free hand hold

## Ranch Riding

Ranch Riding serves to measure the ability of the horse to be functional and a pleasure to ride at a working speed while being used as a means of conveyance from one Western stock horse task to another. The horse's performance should simulate a horse riding outside the confines of an arena and that of a working ranch horse. This horse should be well-broke, relaxed, quiet, soft, and cadences at all gaits. The horse should be responsive to the rider, yield to contact, and make all required transitions smoothly, timely, and correctly. The horse should perform with reasonable speed and be obedient, well-mannered, free, and easy-moving.

Appointments: Hoof polish and trimming inside ears are strongly discouraged. Banded or braided manes are strongly discouraged and could be penalized.

Tack: Horse shall be shown with a stock saddle. Ranch work equipment is recommended; excessive silver show tack is discouraged and could be penalized. Split reins or reins with romal are permitted. Martingales, tie downs, nose bands, or draw reins are prohibited. Carrying of a rope on the saddle is allowed. A judge or show official shall have the authority to require the removal or adjustment of any piece of equipment which, in his opinion, is unsafe, would give the horse an unfair advantage, or constitutes excessive harshness or cruelty.

1. Class consists of pattern work which is ridden individually. For each maneuver, the horse is judged on quality of gaits, response to the rider, manners, and disposition. Maneuvers may include:
  - Walk, trot, and lope both directions
  - Extended trot and extended lope at least one direction
  - Stop and back from any gait
  - Side pass
  - Turns on the hindquarters of up to 2.5 turns
  - Turns on the forehand of up to 180 degrees
  - Change of lead (simple or flying)
  - Walk, trot, or lope over a pole(s)
2. Horse will be given credit for traveling with his head held in a normal position, ears alert, and moving at a natural speed for the gait requested. The horse should be ridden on a relatively loose rein with light contact and without requiring undue restraint. Excessively long reins will be penalized.
3. All transitions should be smooth without undue exaggeration or resistance from the horse.
4. Use of hands: only one hand may be used on reins and hands must not be changed. Reins may be held in any manner. Two hands may be used when using a snaffle bit or bosal on a horse or pony 5 years of age or younger.
5. The judge or show management will select which Ranch Riding pattern will be used. The class must be conducted

inside an arena. The arena may be shortened at the judge's and show management's discretion.

6. To break ties or to resolve close placings, the judge, at his discretion, may require designated contestants to work on the rail or repeat any portion of the pattern.
7. Description of Ideal Gaits
  - a. Walk – The walk should be straight, square, flat footed, relaxed with the horse moving out freely and looking ahead.
  - b. Trot – This gait should be a square two-beat diagonal trot. The trot should be steady, soft, and slow enough for riding long distances. Trots which are rough and hard to sit could be penalized. Excessively slow and uncadenced trots could be penalized.
  - c. Extended trot – The extended trot should show an evident lengthening of stride from the regular trot with the same cadence that will cause an increase in speed. This trot should be level, flat, and steady with the appearance that the horse could hold this gait for an extended distance. Rider may post or sit the extended trot. Holding the saddle horn is permissible at this gait, as might be done in open terrain. When transitioning from the extended trot to the lope, it is permissible to take the horse back a bit (collecting) before loping.
  - d. Lope – This gait should be a three-beat gait that is cadenced, straight, and steady and is comfortable to ride over long distances.
  - e. Extended lope – The extended lope should be an obvious lengthening of stride from the previous lope, be at the same cadence and cause an increase in speed. The gait needs to be steady, quiet, and maintaining the increased speed while being under control.
  - f. Natural gait & Extended natural gait – Non-trotting horses should perform their natural gait where a job/trot is indicated and show a distinctive difference in speed of that gait where an extended job/trot is asked. The natural gait should be smooth and appear effortless for riding long distance.
  - g. Stop (from both lope and trot) – the horse should be in the correct stopping position, both hocks engaged and stopping on the hindquarters.
  - h. Reverse and turns – A horse should turn briskly and flat with front feet close to the ground and holding an inside rear pivot foot.
  - i. Turn on the forehand – Hind end should move around with minimal movement of the front feet
  - j. Side pass – A smooth, fluid, sideways movement with a clean cross-over in front and behind.
8. Scoring will be on a basis of 0-100, with 70 denoting an average performance. The individual maneuvers are scored in half-point increments from a low of -1.5 to a high of +1.5 with a score of 0 denoting a maneuver that is correct with no degree of difficulty.
  - a. One point penalties:
    - i. Two slow/per gait
    - ii. Over-bridled
    - iii. Out of frame
    - iv. Break of gait at walk or jog for 2 strides or less
    - v. Split leg at lope
  - b. Three point penalties:
    - i. Break of gait at walk or jog for more than 2 strides
    - ii. Break of gait at lope
    - iii. Wrong lead or out of lead
    - iv. Draped reins
    - v. Out of lead or cross-cantering more than 2 strides when changing leads
    - vi. Trotting more than 3 strides when making a simple lead change
    - vii. Severe disturbance of any obstacle
  - c. Five point penalties
    - i. Blatant disobedience (kick, bite, buck, rear, etc.)
  - d. Placed below horses performing all maneuvers
    - i. Eliminates maneuver
    - ii. Incomplete maneuver
  - e. Zero score
    - i. Illegal equipment
    - ii. Willful abuse
    - iii. Major disobedience or discipline

## **Stock Seat Equitation**

### **Position in Motion**

Rider should sit to trot/jog and not post. The rider should be close to the saddle at the lope. All movements of the horse should be governed by the use of imperceptible aids. Exaggerated shifting of the rider's weight is not desirable.

### **Class Routine**

All horses are to enter the ring at a walk, whether they enter as individuals or as a class. At county competitions, all classes will begin with individual pattern work. Additional rail work is at the judge's discretion. At the State 4-H Horse Show, all classes will begin with individual pattern work. Rail work may or may not be used for finals classes. In all 4-H Horse Shows, Beginner and Junior exhibitors will be limited to the patterns provided. Senior exhibitors should be prepared to work any pattern called for by the judge. Finalists in the Junior and Senior division may be required to complete an additional pattern(s) at the judge's discretion.

Any work on the rail should include a flat-footed, four-beat walk, a two-beat jog, and a three-beat lope displaying the correct lead. Reversing, if called for, should be done away from the rail. Contestants are expected to stay on the rail at all times and to use the corners of the arena as they are intended when rail work is called for. If a contestant must pass another horse, passing will take place to the inside of the ring of the horse in front. The contestant will take care as to not interfere with the other contestant's horse by cutting off that horse or getting too close to that horse during passing. Exhibitors shall demonstrate sometime during the class routine the ability to back their horses.

### **Mounting and Dismounting**

Riders in the Senior division may be asked to dismount and remount. Riders in the Beginner and Junior divisions will not be required to dismount and remount.

1. Control the horse by taking up the reins with the left hand and adjusting the reins evenly with enough tension to feel the fit and hold the horse steady. While mounting, the ends of the reins should be set on the near side. While riding, the ends of split reins should be carried on the side of the reining hand.
2. Place left foot in the stirrup (if necessary, twist near stirrup with right hand). Grasp saddle horn with right hand. Spring up with your right leg keeping your body close to the horse and settle easily into the saddle.
3. Slip the right foot into the off stirrup and assume basic position.
4. Horse should stand while mounting until given the signal to move out.

### **Scoring & Penalties**

Faults of the horse and rider to be scored accordingly:

- Wrong lead or break of gait
- Stopping rough or crooked
- Failure to maintain a pivot foot
- Imprecise pattern work or rough transitions
- Showing resistance when cued or reined
- Posting the jog-trot
- Stiff, artificial, or unnatural body, leg, arm and /or head position
- Poor position of exhibitor in saddle
- Loose leg with open knee, legs too far forward or back
- Toes pointed down
- Shoulders held crooked or arms held in a straight, unbent position
- Reins too long, too short, or uneven
- Severe faults to be scored accordingly:
  - Failure to follow the pattern
  - Knocking over or working on the wrong side of the cones
  - Touching the saddle

### **Reining**

Each contestant is to perform the required pattern individually and separately. All horses are to be judged immediately upon entering the area, judging ceases after the last maneuver. The horse shall rein and handle easily, fluently, effortlessly and with authority in performing the various maneuvers while using controlled speed.

### **Reins**

Excess rein may be straightened at any place a horse is allowed to be completely stopped during a pattern. When using a romal, no fingers between the reins are allowed. The free hand may be used to hold the romal provided it is held at least 16

inches from the reining hand and in a relaxed position. Use of the free hand any time the horse is not completely stopped is considered to be the use of two hands and a score of zero will be applied.

### **Scoring & Penalties**

All judge's decisions are final. The following will result in disqualification:

- use of more than index (first) finger between reins
- use of two hands—except when:
  - o changing hands or straightening excess rein during a complete stop/rest
  - o using a snaffle or hackamore
- use of romal other than as outlined in this rule book
- failure to complete pattern as written, performing maneuvers other than in specified order, running away or failing to guide where it becomes impossible to discern whether the entry is on pattern
- the inclusion of maneuvers not specified, including but not limited to:
  - o backing more than 2 strides beyond pattern requirements
  - o turning more than 90 degrees outside of pattern requirements
  - o equipment failure that delays completion of pattern
  - o balking or refusal of command where pattern is delayed
  - o jogging in excess of one-half circle or one-half length of the arena
  - o over spins of more than 1/4 turn
  - o fall of either horse or rider
  - o dropping a rein that contacts the ground while the horse is in motion
  - o failure to have correct exhibitor number displayed
  - o failure to wear appropriate western attire

The following are penalties (from least to most severe):

- failure to remain a minimum of 20 feet from wall or fence
- in patterns requiring a run-around, failure to be in the correct lead when rounding the end of the arena
- over spinning
- starting circles at a jog or exiting rollbacks at a jog up to 2 strides, jogging beyond 2 strides but less than 1/2 circle or 1/2 the length of the arena.
- break of gait, freezing up in spins or rollbacks, not completely passing the specified marker before initiating a stop position, starting or performing circles or eights out of lead
- on walk-in patterns: cantering prior to reaching the center of the arena and/or failure to stop or walk before executing a canter departure
- on run-in patterns: failure to be in a canter prior to reaching the first marker, spurring in front of cinch, use of either hand to instill fear or praise, holding saddle with either hand, blatant disobedience including kicking, biting, bucking, rearing and striking

### **Reining Terminology**

- Circles: Maneuvers at the lope, of designated size and speed, which demonstrate control, willingness to guide and degree of difficulty in speed and speed changes. Circles, performed at a lope, are run in a designated location at a defined speed and size with a common center point (usually the center of the arena even with the center marker). All large, fast circles should be of consistent speed and size. All small, slow circles should also be of a consistent speed and size. Circles should be circles, not egg or elliptical shaped.
- Flying Lead Changes: The act of changing the leading (or inside) front and rear pair of legs when changing the direction of travel. To be considered correct, this maneuver must be performed at a lope with no change of gait or speed, be performed at exact location as specified by the pattern and the change must take place on both the front and rear legs in the same stride.
- Sliding Stop: The rider, while loping, cues the horse to stop. The horse brings back legs up underneath in a locked position that will cause it to begin sliding on the back feet. The horse maintains forward movement by continuing to run with the front feet and using the head and neck to balance. Throughout the stop, the horse continues in a straight line while the back feet slide over the ground.
- Rundown: The horse gallops or "runs" down the side or center of the arena. A run down is a required movement before a sliding stop or roll back.
- Rollback: The horse runs to a stop, rolls the shoulders back in the opposite direction completing a 180' (1/2 turn) reversal of forward motion and departs in a canter. This is all one continuous motion with no hesitation.
- Spins: The horse is asked to turn the front end around in a series of 360 - degree turns, executed while the inside back foot remains in one spot. Correctly done, the horse will cross the outside front leg over the inside front leg,

effortlessly moving the front end around in a smooth, flowing manner. Higher marks are given to the horse that shows no resistance.

- **Pause/Hesitate:** The horse is asked to stand still for a few seconds to “settle” between certain movements in the reining pattern. Pauses are not judged as a movement per se, but a horse that is ill-mannered or behaves with impatience when asked to wait will be penalized.

### **Pattern Clarification**

Suggested arena pattern size is 150' x 50' (length X width). Suggested markers should be placed along both walls/fences with the center cone to be placed first and the end cones to be placed approximately 40' from the center cone. This is suggested size and placing of the markers and this may vary with the different sizes of arenas. The judge may indicate where to place the markers. NOTE: Markers should be placed along both fences/walls.

Patterns are worked as stated, not as drawn. The drawing is provided to give the general idea of what the pattern will look like in the arena. Each pattern is drawn so that the bottom of the drawing represents the end of the arena entered by contestants and must be run as such. If the arena has only one gate and it is in the exact middle of a side, that side represents the right side of the page the pattern is drawn on and the contestant must walk to the end of the arena to begin the pattern. (With the exception of pattern # 3 which starts in the center of the arena.)

Where designated in the pattern for stops to be beyond a marker, the horse should begin the stop after passing the specified marker.

### **Trail**

This class will be judged on the contestant's ability to properly ride and /or conduct his/her horse through the various obstacles according to the judge's direction. The gait(s) between the obstacles will be at the discretion of the judge. The judge shall give as much consideration to the ability of the contestant to properly exhibit his/her horse as is given to the performance of the horse. The judge may ask for an additional obstacle to select a champion or to break a tie. Note: Only exhibitors will be allowed in the ring during the final walk-through. No coaches or advisors are allowed on the course.

This is a judged event utilizing some timed obstacles. Reins are to be used with one hand (with the exception of using a Bosal or ringed snaffle), and the rein hand must not be changed during the class except when working the gate or under direction of the pattern.

Beginner trail is walk/trot only. Beginners will ride through an open gate.

### **Trail Obstacles**

A minimum of six obstacles will be used, three mandatory and three others selected from the approved list or by request of the judge. Each mandatory obstacle (except gate) must be cleared within 30 seconds of entering the obstacle or the contestant will be dismissed from the ring. No rail work will be used.

The judge has the option of limiting performance at any optional obstacle to two approaches or 30 seconds.

### **Mandatory Obstacles**

1. Opening rope gate (see \* below), passing through and closing gate (45 -second time limit). Changing hands on gate or turning loose of gate is to be penalized.
  - A clearly visible starting line must be located six feet prior to the gate. This starting line can be marked on the ground or designated with widely set markers that are visible to the judge and rider. Time starts once a foreleg crosses the starting line and stops when the rider is through the gate and it is latched.
  - Counties have the option to use a wooden or rope gate at their county 4-H horse show.
  - The gate shall be freestanding and may be 6-8 feet wide, with no feet restricting supports. Suggested gate assembly: use two pole-bending poles, weighted properly, with a rope securely tied to one pole and easily slipped over the other.
  - Gate type (wooden or rope) must be specified on show pattern.
2. Ride over at least four logs or poles (30-second time limit). These can be in a straight line, curved, zigzag or raised (not greater than 12 inches). The distance between the poles is measured over the horse's path and shall be 15 to 24 inches for walkovers, 3 to 3 feet 6 inches for trot-overs, and 6 to 7 feet for lope-overs. Elevated walkovers shall be a minimum of 22 inches apart.
3. Ride over wooden bridge. (30 –second time limit). The sides on the bridge for Trail need to be removed to create a flat bridge with no sides on for safety reasons.

\* **NOTE:** For safety reasons, Beginners are to ride through an open gate and leave the gate open. Beginner contestants

will trot instead of lope.

**Optional Obstacles**

- Water hazard (ditch or shallow pond).
- Hobble or ground-tie horse.
- Carry object from one part of the arena to another.
- Back horse through "L" shaped course (minimum of 28 inches).
- Handle slicker.
- Open and close mailbox.
- Dismount and lead horse over obstacles no less than 14 inches and no more than 24 inches in height.
- Pull an object toward the horse with lariat or rope.
- Others upon request of the official judge.

## English Performance & Equitation

### Hunt Seat Equitation, Hunter Equitation Over Fences, & Pleasure Driving

Equitation classes recognize the rider's ability to ride a horse correctly and to use various aids required for a horse to perform basic maneuvers. Riders will be judged on basic position in saddle; position and use of hands, legs and feet; ability to control and show the horse; and suitability of horse to rider. The rider's ability to execute maneuvers correctly shall be considered more important than the horse's performance.

#### Tack

##### Bits

- An English snaffle (no shanks), Kimberwicke, Pelham, and/or full bridle (with 2 reins), all with cavesson nosebands, and plain leather brow bands, must be used.
- In regard to mouthpieces, nothing may protrude below the mouthpiece. On broken mouth- pieces only, connecting rings of 11/4 inch or less in diameter, or connecting flat bar of 3/8 to 3/4 inch (maximum length of 2 inches) and that lie flat in the horse's mouth are acceptable. Smooth round, twisted, double twisted; slow twist, straight bars, or solid mouthpieces with a maximum of a 1 inch high port are acceptable. All mouthpieces must be a minimum of 5/15 inch in diameter, snaffles to be measured 1 inch from cheek.
- English bits of any style featuring cathedral or donut mouthpieces or rough, sharp material are not acceptable.

Optional Appointments - un-rowelled English-type spurs (slip-ons are acceptable) and riding crops or whips are optional.

Prohibited Tack - Draw reins, martingales, tie-downs, hackamores, flash nosebands, Mexican (crossed figure-8), dropped nosebands, and horse leg boots of any type are illegal.

### Hunt Seat Equitation

#### Tack

Bridles - English snaffle (no shank), Pelham (with two or four reins), Kimberwicke and/or full bridle with plain brow bands are required.

Saddles - English or forward seat skirted hunting saddles must be used. They may have suede and /or suede insert on skirt and either cloth or leather lining. Girth may be leather, web, cord, or linen. Hunting breastplate is optional.

#### Class Conditions & Rules

- To mount: reins in left hand, place left hand on withers, grasp stirrup leather with right hand and insert left foot in stirrup and mount.
- To dismount, either step or slide down. Hand should be over and in front of horse's withers, knuckles 30 degrees inside the vertical, hand slightly apart and making a straight line from the horse's mouth to rider's elbow.
- Method of holding reins is optional. All reins are to be picked up at the same time.
- Eyes should be up with shoulders back, toes slightly out and ankles flexed in.
- Heels should be down and calf or leg in contact with horse and slightly behind girth.
- Gaits may include the walk, trot, extended trot, canter and hand gallop.

#### Basic Riding Position

- The rider should sit in a comfortable, balanced, and relaxed manner while maintaining an erect upper body with eyes up and looking forward.
- The rider's legs should have a slight bend and hang beneath the rider such that when viewed from a profile, a straight line (approximately) can be drawn through the rider's ear, shoulder, hip and heel.
- The irons should be placed under the balls of the feet and not under the toe or against the heel.
- Toes should be turned only slightly out with ankles flexed in toward the horse in a comfortable position.
- The lower leg should be held such that light contact is maintained with the horse.

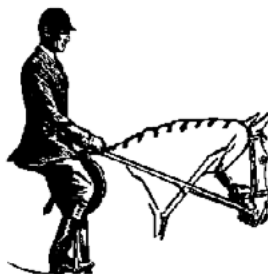

- Arms and hands should be held in a comfortable, relaxed manner with upper arms held in a straight line with the body. The elbow is bent such that the lower arm and hands are in a straight line to the bit.
- Hands should be slightly over and in front of the withers with knuckles 30 degrees inside the vertical.

### **Position in Motion**

- At the walk and slow trot, body should be vertical with slight motion in the saddle.
- At a posting trot, the body should be inclined forward with slight elevation in the saddle.
- At the canter, the body should be halfway between the posting trot and the walk.
- At the gallop, and while jumping, the body should be at a similar inclination as when at a posting trot.

### **Class Routine**

All horses are to enter the ring at a walk, whether they enter as individuals or as a class. At county competitions, all classes will begin with individual pattern work. Additional rail work is at the judge's discretion. At the State 4-H Horse Show, all classes will begin with individual pattern work. Rail work may or may not be used for finals. In all 4-H Horse Shows, Beginner and Junior exhibitors will be limited to the patterns in the 4-H Horse Project Show Guide. Senior exhibitors should be prepared to work any pattern called for by the judge. Finalists in the junior and senior division may be required to complete an additional pattern(s) at the judge's discretion.

Rail work: Class contestants are to enter the ring, turn to the right and proceed at a counter-clockwise direction. Contestants shall proceed at least once around the ring at each gait, and on command, reverse and repeat. The order to reverse must be executed away from the rail. Light contact with the horse's mouth is required. Entries shall then line up on command and any or all riders may be required to execute any appropriate tests. Judges are encouraged to call for additional tests. No more than eight contestants on the rail at a time during the hand gallop.

Any work on the rail should include a flat-footed, four-beat walk, a two-beat trot, and a three-beat lope displaying the correct lead. Reversing, if called for, should be done away from the rail. Contestants are expected to stay on the rail at all times and to use the corners of the arena as they are intended. If contestants must pass another horse, passing will take place to the inside of the ring of the horse in front. The contestant will take care as to not interfere with the other contestant's horse by cutting off that horse or getting too close to that horse during passing. No more than eight contestants on the rail at a time during the hand gallop. Exhibitors shall demonstrate the ability to back their horse sometime during the class routine.

It must be remembered, above all, that an equitation horse should respond instantly and smoothly to all aids given by the rider. Light contact with the horse's mouth is required.

### **Scoring & Penalties**

The following are faults and should be judged accordingly:

- Wrong lead or break of gait
- Being on the wrong diagonal
- Stopping rough or crooked
- Imprecise pattern work or rough transitions
- Showing resistance when cued or reined
- Stiff, artificial or unnatural body, leg, arm, and /or head position
- Poor position of exhibitor in saddle
- Loose leg with open knee, legs too far forward or back
- Toes pointed down
- Shoulders held crooked or arms held in a straight unbent position
- Reins too long, too short, or uneven

Severe faults to be scored accordingly:

- Failure to follow the pattern
- Knocking over or working on the wrong side of the cones
- Touching the saddle

### **Hunt Seat Tests (from which the judge must choose)**

Tests may be performed either collectively or individually, but no other tests may be used. Instructions must be publicly announced.

1. Back.
2. Hand gallop and halt.
3. Figure eight at trot, demonstrating change of diagonals. At left diagonal, the rider should be sitting the saddle when left



front leg is on the ground. At right diagonal, the rider should be sitting the saddle when right front leg is on the ground. When circling clockwise at a trot, rider should be on left diagonal. When circling counter-clockwise, rider should be on right diagonal.

4. Figure eight at canter on correct lead demonstrating simple change of lead. (This is a change where the horse is brought back into a walk or trot and restarted into a canter on the opposite lead.) Figure eight is to be initiated in the center of two circles so that one lead change is shown.
5. Work collectively at a walk, trot or canter.
6. Ride without stirrups, or drop and pick up stirrups.
7. Dismount and mount (Seniors only).
8. Turn on the forehand.
9. Figure eight at canter on correct lead demonstrating flying change of lead.
10. Execute serpentine at a trot and /or canter on correct lead demonstrating simple or flying changes of lead.
11. Change leads down center of ring demonstrating a simple or flying change of lead.
12. Canter on counter lead. No more than 12 horses may counter-canter at one time.
13. Turn on the haunches.

## Hunter Equitation Over Fences

### Class Conditions

There will be a minimum of four obstacles; horses are to make a minimum of eight jumps. At least one warm-up jump should be provided. There will be NO jump offs. Course must be posted at least one-hour before scheduled time of class. Seniors are to have at least one change of direction. All hunters will be permitted to walk the official course (without horse) immediately prior to the class.

Note: Only exhibitors will be allowed in the ring during the final walk-through. No coaches or advisors are allowed on the course.

Protective boots may be used in Hunter Equitation over Fences.

Height of Obstacles (measured from the ground to the center of jump)

	Minimum	Maximum
Juniors	18"	30"
Seniors	24"	36"

### Scoring & Penalties

Riders will be judged on seat, hands, and ability to control and show the hunter over fences. Particular emphasis shall be placed on the rider's basic position in the saddle, including the strength of the leg position and suppleness of hand. The rider shall also be judged on the smoothness of performance and manners of the horse. An even hunting pace is preferred.

Judges must penalize unsafe jumping and bad form over fences, whether the fence is touched or untouched. At combination, the faults committed at each obstacle are considered separately. In case of a refusal or run-out at one obstacle in a combination, the competitor may re-jump the entire combination. Knockdowns, refusals and touches should be penalized. Three refusals result in elimination. Fall of the horse and / or rider results in elimination.

### Knockdowns

When a horse attempts to jump an obstacle and knocks down the obstacle, or any portion of it, it is considered a knockdown and a penalty of four faults is given. (Exception: When a horse knocks down all or any portion of an obstacle while refusing, it is not to be scored as a knockdown, but given the correct number of faults for that refusal.)

- Knockdowns of obstacles or the cause of any portion of an obstacle, standard or wing to be knocked down by any portion of the horse, rider, or equipment: four faults. No penalties for touch of obstacle, standard or wing with any portion of the horse, rider or equipment.
- Circling once upon entering the ring and once upon leaving is permissible. Any additional circling or unnecessary showing of fence to horse: three faults.
- First refusal (anywhere on course): three faults.
- Second refusal: six faults.
- Third refusal: elimination.
- A fall of horse and /or rider: elimination.
- Failure to enter the ring within one minute of being called: elimination.
- Failure to complete course, going off course, jumping out of order: elimination.

- In cases of broken equipment, the rider will be disqualified. In case of loss of shoe, rider may either continue without penalty or be eliminated.
- At a brush element, the touch of the brush only without touching the framework is not scored as a fault.
- Charging will be penalized.

### **Suggestions for Jumping**

Jumps should be a minimum of 48 feet apart, but all intervals must be in multiples of 12 feet (e.g. 48 feet and 60 feet apart from the point of landing to the point of take-off in the next jump). The distance from take-off or landing from the jump is usually equal to or up to 1 ½ times the height of the jump. For a jump set at 24 inches, this would be 24 – 36 inches from the fence. The take-off distance may be taken into consideration when spacing jumps.

### **Pleasure Driving**

Pleasure Driving classes are broken into five divisions by horse size: miniatures (38" and under at the last mane hair), ponies (Over 38" to 56" at the withers), stock horse (Paints, Quarter Horses, Appaloosas), pleasure type (Arabians, Morgans, Saddlebreds, NSH), and draft (Belgians, Percherons, Clydesdales, Shires etc.) due to safety reasons. Please Note: Pleasure driving horse height will be included with the official State 4-H Horse Show entry. Judges will be instructed to choose the Grand and Reserve Champions from across the five separate divisions within each age division (Juniors & Seniors).

Exhibitors shall compete in the pleasure driving class with their animals safely harnessed to an appropriate vehicle. One attendant may head (hold in line up) each horse. Junior exhibitors are allowed to have an adult accompany them. In the senior division, no other person is permitted in the vehicle while the horse is being exhibited. No pets shall be allowed in such vehicle during exhibition.

### **Tack**

#### **Vehicle**

- Suitable for style of driving. Pleasure type two or four wheeled cart or buggy. Cart or buggy type wheels a minimum of 19 -inches in diameter and with one or two seats. No stirrup type carts or sulkies may be used.
- Vehicle must be clean, safe, and in good repair.

#### **Harness**

- A collar or breast collar harness and standard bridle with snaffle or curb bit may be used. If curb bit is used, curb strap or curb chain must meet judge's approval and requirements as stated for Western Division.
- Harness must be safe, clean, and properly adjusted.

Whip - Drivers will carry a whip in hand.

Optional Tack - Dash and basket cover for vehicle is optional. Check reins, blinkers, breeching, martingales and cavesson nosebands are optional.

Prohibited Equipment - No wire curbs, regardless of how padded or taped, may be used.

### **Basic Driving Position**

- The driver must be straight in the back, sit back in the seat, the feet reaching to a foot rest with the elbows slightly forward of the body.
- Whip in hand.
- The driver is usually seated on the right to access the brake at all times.

### **Final Preparation**

- The driver must check the hitch for appropriate adjustments for safe driving.
- The driver must achieve appropriate tension on the lines and have the whip in hand.
- The driver should know the location of the judge and the ring steward.
- An experienced driver may be on the seat beside a junior driver. If assistance is given, either via the lines, whip, or voice command the driver will be penalized.

### **Class Procedure**

1. Enter the ring with the unit bearing to the right at a safe speed.
2. When all units are in the ring, you should space yourself and follow the directions of the ring steward. Always have sufficient clearance between your unit and the preceding unit to stop or make adjustments. Use of whip may be necessary. Correct posture should be maintained at all times.
3. Upon direction you execute the gaits appropriate for your division. Pleasure Type and Stock Horse drivers may pass on

the inside track. Draft Harness drivers do not pass.

4. At the direction of the ring steward, the driver will reverse direction on the diagonal assuming an inside path until the rail is clear.
5. Upon direction the units will be asked to line up in the center of the ring. This should be executed with a smooth and controlled stop. Horses and vehicle should be brought to a complete square stop without abruptness or veering. At the halt, horses should stand attentive, motionless and straight with the weight evenly distributed over all four legs and be ready to move off the slightest indication from the driver.
6. After stopping, the horses should stand quietly. The driver may relax the lines but should hold them in anticipation of starting, whip in hand. A header is optional.
7. At the request of the judge the driver will rein back. Rein back is defined as a backward movement in which the legs are raised and set down simultaneously in diagonal pairs with the hind legs remaining well in line. To be performed in two parts:
  - a. The horse must move backward at least four steps in an unhurried manner with head flexed and straight, pushing the vehicle back evenly in a straight line. The driver should use quiet aids and light contact.
  - b. Move forward willingly to former position using the same quiet aids.
8. The judge will complete an inspection of the unit.

### **Scoring & Faults**

Judging begins when the unit enters the ring. The driver will be evaluated throughout the class on posture, use of hands to gather and adjust lines, use of whip, and use and position of arms and legs. The driver's arms should be forward of the body while the horses work as a smooth consistent unit. Drivers will be evaluated on ability to command horses along the rail at a walk and trot, reverse direction, line up, stop, stand, and back. A figure eight or swing (cut) may be requested at the discretion of the judge.

The horse(s) are to be judged on performance with and suitability for the youth driver. The horse(s) must be clean, groomed, and presented in the most positive manner.

### **Judge's Suggested Scoring System**

20 points	Appearance of Entry	<ul style="list-style-type: none"> <li>• Grooming (5 points)</li> <li>• Condition of the animal (5 points)</li> <li>• Fit of harness (5 points)</li> <li>• Equipment condition/cleanliness (5 points)</li> </ul>
70 points	Control of the Animal	<ul style="list-style-type: none"> <li>• Walk (20 points)</li> <li>• Trot (20 points)</li> <li>• Reverse Direction (10 points)</li> <li>• Backing (10 points)</li> <li>• In the lineup (10 points)</li> </ul>
10 points	Driver	<ul style="list-style-type: none"> <li>• Appearance (5 points)</li> <li>• Attitude (5 points)</li> </ul>

### **Pleasure Driving Guidelines**

The following guidelines should be followed for Stock Horse, Pony, and Miniature Horse Pleasure Driving Divisions. Pleasure Type and Draft divisions have their own guidelines.

The Stock Horse is expected to present a picture of relaxation and suppleness while moving forward with purpose and control.

### **Gaits**

- Walk - A free, regular and unconstrained walk of moderate extension is ideal. The horses should walk energetically, but calmly, with even and determined pace. The walk is a four beat gait.
- Slow Trot - The horse should maintain forward impulsion while showing submission to the bit. This trot is slower and more collected while maintaining a steady cadence.
- Working Trot - This is a controlled lengthening of strides as the horses go forward freely and straight; engaging the hind legs with good hock action; on a taut, but light rein; the position being balanced and unconstrained. The steps should be as even as possible.

### **Pleasure-Type Pleasure Driving Guidelines**

The Pleasure Driving Horse is expected to present a picture of brilliance and animation while moving forward with elegance and energy.

#### **Gaits**

- Walk - A flat-footed, free, rapid, elastic, ground-covering gait with a four-beat cadence.
- Pleasure Trot - A pleasant, easy-going trot with elasticity and freedom of movement.
- Road Trot - A balanced trot maintaining free forward impulsion with sufficient speed to be ground-covering but with enough collection to allow the horse to maintain the gait at speed for an extended period of time. Form should not be sacrificed for speed, and excessive speed at the expense of form or balance will be penalized.

### **Draft Pleasure Driving Guidelines**

The Draft Horse is expected to present a picture of strength and boldness while moving forward with precision and power. There will be no passing in the show ring.

#### **Gaits**

- Smooth Walk
- Smooth Trot

### **Team Hitch**

Three divisions will be offered: miniature/pony (56 inches or less), horse, and draft. Youth may participate in only one of the divisions. Note: Youth are to indicate kind of team on entry card; horse height will be included with the official State 4-H Horse Show entry, classes will be sorted by horse height.

A team hitch will be treated as one horse, one entry. Horses that meet the characteristics of draft breeds will be considered Draft. An adult must accompany each driver on the seat of the wagon. Restrictions on wagons apply only to the safety of other exhibitors, spectators, and horses. Advertising, names or other wording on wagons is prohibited.

Horses should be presented in a clean, thrifty, well-cared-for condition, neither thin nor excessively fat. Draft horse tails may be natural or docked, braided or left long, and should fit the proportions of the horse. Both mares and geldings are generally shown in hitch classes with their manes rolled, but this is optional. Feet may be shod or unshod, but should be properly trimmed and clean. Black or natural hoof dressing, paint, etc. is acceptable.

### **Basic Driving Position**

- The driver must be straight in the back, sit back in the seat, the feet reaching to a foot rest with the elbows slightly forward of the body.
- The driver is usually seated on the right to access the brake at all times.
- Enter the ring with team under control and alert.

### **Class Conditions & Rules**

A single team hitch (two horses harnessed side by side, one on either side of the pole) with properly adjusted hame and collar style work or show harness is required.

Always have sufficient clearance between your team and the preceding wagon to stop or to turn out and pass. All passes should be made to the inside of the arena away from the rail.

There is no passing in the Draft Horse division. Safety of your hitch and others should always be on your mind. You should know at what speed within each gait your team looks best. Pass a slower team rather than slow your team, but do so with care. When the ring steward asks for the reverse in direction, adequate spacing between hitches must be kept and passing must cease.

### **Class Procedure**

1. Enter the ring at the walk.
2. Exhibitors will be asked to walk, trot, reverse direction, line up, and back their teams.
3. The class may include individual workouts as follows:
  - a. Line up at the end of the ring.
  - b. Work a figure eight.
  - c. Stop in front of the judge and back the team.

### Judge's Suggested Scoring System

20 points	Appearance of Entry	<ul style="list-style-type: none"><li>• Grooming (5 points)</li><li>• Condition of the animal (5 points)</li><li>• Fit of harness (5 points)</li><li>• Equipment condition/cleanliness (5 points)</li></ul>
70 points	Control of the Animal	<ul style="list-style-type: none"><li>• Walk (20 points)</li><li>• Trot (20 points)</li><li>• Reverse Direction (10 points)</li><li>• Backing (10 points)</li><li>• In the lineup (10 points)</li></ul>
10 points	Driver	<ul style="list-style-type: none"><li>• Appearance (5 points)</li><li>• Attitude (5 points)</li></ul>

### Timed Performance Events

Barrel Racing, Pole Bending, Flag Race, Break-away Roping, Tie-down Calf Roping, and Dally Team Roping events are included in timed performance events. If clarification of rules is needed for the Timed Performance Events, officials will refer to the South Dakota 4-H Rodeo Rules and Regulations. If further clarification is needed, officials will refer to the National High School Rodeo Association Rules, By-Laws, and Constitution.

All timed event participants must wear white, long-sleeved shirts with the sleeves rolled down, and a western hat or helmet. Failure to do so will result in disqualification at the gate. Please refer to the previous pages for complete rules for participation in the SD State 4-H Horse Show.

#### Tack

Western-type equipment must be used. Use of a hackamore or other type of bridle is the choice of the contestant; however, the flagger or field judge may prohibit the use of bits or equipment which he/she considers severe.

#### **Barrel Racing**

The Barrel Racing Cloverleaf Pattern is designed to test the speed and maneuverability of the horse.

#### Class Rules

- The clover-leaf pattern is the only approved pattern in this event.
- A clearly visible start line shall be provided.
- Two stopwatches or an electric timer with back-up watches shall be used.
  - If the electric eye does not work, the hand-held time will be used.
  - If the electric eye fails for more than 1/3 of the runs in a go-round, all contestants will have to take the hand-held times.
  - If there is no time recorded (either eye or hand-held) a rerun, carrying penalties forward, will be run at the end of that performance.
  - In the event that the eye fails to operate completely, then all hand-held times will be used.
  - The electric eye and hand-held times will be used through the 1000ths, unless the technology to do so is not available.
- The barrels and starting line will be permanently marked for the entire go-round.
- The arena will be dragged/raked at regular intervals, to be determined by the management. Turnouts and releases must be included in this count.
- The contestant or horse may touch the barrel.
- The contestant may not start the pattern until the horse has reached the plane of the entry gate. No running starts allowed.
- If the gate is centrally located, the contestant must keep motion toward the arena whether forward, sideways, or backward.
- If the gate is off-center of the pattern, a single spin or pivot is acceptable in either direction.
- Arena gate must be closed and latched immediately after the contestant enters the arena and will be kept closed until the pattern is completed and the horse is under control.
- Time will start when any portion of the horse breaks the plane of the start/finish line.
- In the event of a tie, a runoff will be held. The horse declared the winner in the runoff must complete the pattern within two seconds of its original time or the runoff must be held again.

## **Penalties**

- The judge will not flag the contestant out until time is recorded. The judge is to flag time, then flag the contestant out if the run is not legal.
- Knocking over a barrel will cause an automatic five second penalty per barrel. Should the barrel be knocked over and it sets up on opposite end, the five second penalty will be assessed.
- Not following the cloverleaf pattern will result in a no time.
  - A broken pattern shall be defined as breaking forward motion to retrace tracks to finish the pattern and /or passing the plane of the barrel on the off side.
  - Example: Should a contestant run by a barrel and have to back up or turn around and retrace their tracks, this would be considered a broken pattern.
  - Failure to follow the course or crossing over the start/ finish line prior to completion of the pattern will be considered a broken pattern and will result in a no time.
- Any assistant helping barrel racers will not be allowed to go past the plane of the main arena gate when they are entering the arena or the contestant will be disqualified.

## **Barrel Racing Course**

### **Class Routine**

The contestant may start on either the right or left barrel.

- Right run barrel pattern: At a signal from the starter/ timer, such as the word "go" or "raising the flag", the 56 contestant will go to barrel #1, turn to the right around the barrel, complete a 360 degree turn, then proceed to barrel #2, turn left around the barrel with another turn of 360 degrees, go on to barrel # 3, turn left around the barrel and sprint the horse to the finish line.
- Left run barrel pattern: The barrel course may also be run to the left. For example, the contestant will start to barrel #2, turn left around this barrel, proceed to barrel #1, turn right, then ride to barrel # 3, turn to the right again and sprint to the finish line.

### **Pattern Standards**

The course must be measured exactly. The following standards should be used to set the barrel racing pattern (refer to diagram):

- Minimum of 25 yards (75 feet) between start/finish line and arena fence to allow for stopping.
- Distance between barrels 1-3 and 2-3: minimum-20 yards, maximum-35 yards.
- Distance between barrels 1-2: minimum-20 yards, maximum-30 yards.
- Minimum of 20 feet from each barrel to the fence.
- If the course is too large for the available space, the pattern shall be reduced in 5 yard increments until the pattern fits the arena. The distance from barrel number3 to the finish line need not be reduced 5 yards at a time if there is sufficient room for a horse to stop.

## **Pole Bending**

The Pole Bending pattern is to be run around six poles.

### **Class Routine**

- A clearly visible start line shall be provided.
- Two stopwatches or an electric timer with back-up watches shall be used.
  - If the electric eye does not work, the hand-held time will be used.
  - If the electric eye fails for more than 1/ 3 of the runs in a go-round, all contestants will have to take the hand-held times.
  - If there is no time recorded (either eye or hand-held) a rerun, carrying penalties forward, will be run at the end of that performance.
  - In the event that the eye fails to operate completely, then all hand-held times will be used.
  - The electric eye and hand-held times will be used through the 1000ths, unless the technology to do so is not available.
- The poles and starting line will be permanently marked for the entire go-round.
- The arena will be dragged /raked at regular intervals, to be determined by the management. Turnouts and releases must be included in this count.
- The contestant or horse may touch the pole.
- The contestant may not start the pattern until the horse has reached the plane of the entry gate. No running starts allowed.
- If the gate is centrally located, the contestant must keep forward motion toward the first pole. If the gate is off-center of

the pattern, a single spin or pivot is acceptable in either direction.

- Arena gate must be closed and latched immediately after the contestant enters the arena and will be kept closed until the pattern is completed and the horse is under control.
- Time will start when any portion of the horse breaks the plane of the start/finish line.
- In the event of a tie, a runoff will be held. The horse declared the winner in the runoff must complete the pattern within two seconds of its original time or the runoff must be held again.

### **Penalties**

The judge will not flag the contestant out until time is recorded. The judge is to flag time, then flag the contestant out if the run is not legal.

- Knocking over a pole will cause an automatic five second penalty per pole.
- Not following the pole bending pattern will result in a no time. A broken pattern shall be defined as breaking forward motion to retrace tracks to finish the pattern and /or passing the plane of the pole on the off side.
  - o Example: Should a contestant run by a pole and have to back up or turn around and retrace their tracks, this would be considered a broken pattern.
  - o If a pole is knocked down and the contestant does not follow the weave pattern around the original base position of the fallen pole, it is considered a broken pattern.
  - o Failure to follow the course or crossing over the start/finish line prior to completion of the pattern will be considered a broken pattern and will result in a no time.
- Any assistant helping pole benders will not be allowed to go past the plane of the main arena gate when they are entering the arena or the contestant will be disqualified.

### **Pole Bending Course**

#### **Class Routine**

The contestant may start to the right or to the left of the first pole and then run the remainder of the pattern as follows:

Run down to the sixth pole and turn the horse back, weave/bend in and out of the poles until the first pole, turn the horse back to weave/bend in and out to the sixth pole, run back to the finish line.

#### **Pattern Standards**

The pole bending pattern is run around six poles. The course must be measured exactly. The following standards should be used to set the pole bending pattern (refer to diagram):

- Minimum of 25 yards (75 feet) between start/finish line and arena fence to allow for stopping.
- The distance from the starting line to the first pole must be 21 feet.
- The poles must be spaced 21 feet apart.
- The end pole must be at least 20 feet from the fence.
- Poles must be 6 feet in height with no base larger than 14 or less than 12 inches in diameter.
- Poles must be set on top of the ground.
- Poles must be straight in line.

### **Flag Race**

The objective of this event is for the rider to race through the course, mounted horseback from either direction. Deposit a flag in the first bucket; retrieve a flag from the second bucket; and cross the finish line.

#### **Class Routine**

Time starts when the rider crosses the start/finish line the first time and ends when they complete the pattern and cross the second time. A clearly visible starting line shall be provided.

Two stopwatches or an electric timer with back-up watches shall be used. If the electric eye does not work, the handheld time will be used. If the electric eye fails for more than 1/3 of the runs in a go-round, all contestants will have to take the hand-held times. If there is no time recorded (either eye or hand-held), a rerun, carrying penalties forward, will be run at the end of that performance.

### **Penalties**

The pattern is a horseshoe pattern on the outside of the barrels. Any deviation will be a no time. The contestant must carry the flag in their hand. Carrying the flag anywhere but in their hand carries a 2-second penalty.

A contestant will be disqualified for any of the following:

1. Knocking over the barrel or tipping a bucket.

2. Dropping the flag on the ground.
3. Failure to keep the flag in first bucket.
4. Using the flag as a whip on the horse.
5. Crossing the start/finish line without the flag from the second bucket.
6. Breaking the pattern.

### **Class Routine**

- The contestant may run the course in either direction, from left to right or from right to left. In either case, the bucket on the first barrel the contestant comes to should not have a flag in it.
- The bucket on the second barrel the contestant comes to should have a flag in it at the start.
- The contestant is given a flag either just prior to or as he enters the arena.
- The contestant then races across the start/finish line toward the first barrel.
- As the contestant turns around the first barrel, s/he should place the flag into the oats in the first bucket, then cross over to the second barrel and take the flag out of the oats and race back across the start/finish line.

### **Pattern Standards**

Two 5-gallon buckets set on 55-gallon barrels will be needed. Whole oats will be used in buckets. The oats must be 4 inches from the top of both buckets. The flag must be at least 16-inches long. On the retrieving bucket, the top of the flag must protrude above the rim of the bucket a minimum of 5 inches. Barrels with buckets on top should be set as close as possible to the following dimensions: 100 feet from start/finish line to first barrel. Barrels should be 40 to 75 feet apart, arena permitting. There shall be a minimum of 20 feet from either barrel to arena fence or wall.

### **Roping Events**

There will be no video replay for classes that have arbitration reviews. Judge's ruling is final.

The calf or steer belongs to the contestant when he calls for it regardless of what happens, except in the case of the following:

- mechanical failure
- animal escapes from the arena
- the judge rules that the contestant was fouled by the barrier

In the event of any of the above failures, the contestant will receive the original animal back with a lap-and-tap (no barrier used) start. Time already accumulated will be added to time used to complete the qualifying run. If time is not recorded, the contestant will receive a 10-second penalty for any jump or loop used.

Contestants must make an attempt on a live animal at a County 4-H Horse Show to qualify for the State 4-H Horse Show Roping Events. A contestant must be on his/her horse and his/her horse must break the plane of the barrier with his/her calf/steer breaking the plane of the score before he/she is allowed to compete.

Contestants must wear a cowboy hat or helmet, long-sleeved shirt, western boots, and western pants in the arena at all times, whether competing or not, and must not roll up sleeves. Violators of this rule may be disqualified upon the discretion of the judges or the arena director.

Once the performance has started, the score line and length of box will not be changed.

The catch pen gate will be closed while the contestant is roping.

### **Breakaway Roping**

The time limit is 30 seconds. All penalties will be assessed after the run. Ropers have the option of coming out of either box.

### **Tack & Equipment**

Two loops will be allowed if two ropes are carried. The second rope must remain tied until used. Two loops cannot be thrown unless two are carried. A roper who does not carry two loops is not allowed to run again.

### **Class Routine**

- Ropes must be tied to the saddle horn with nylon string tied at the knot on the rope. The rope should have a knot at the end with no tail.
- The rope may not be run through the bridle, tie down, neck rope or any other device.
- A white flag must be attached to the knot end of the rope.
- The calf's head must pass through the loop. The loop must draw down upon any part of the calf's body behind the head.



- If the field judge flags out a roper that still legally has one or more loops coming, the judge may give the same calf back, lap and tap, plus time already lapsed and any barrier penalties. If time was not recorded, the contestant will receive a 10-second penalty for any loop used. Contestant will only be granted remaining loops, not additional loops.

### Penalties

The judge will not flag the contestant out until time is recorded. The judge is to flag time, and then flag the contestant out if the run is not legal. A 10-second penalty will be given for beating or breaking the barrier.

The following actions will result in a no time/disqualification:

- Not releasing the rope from the hand when roping the calf.
- Abusive treatment of calf or horse.
- Contestant breaking the rope away from the horn by hand. \*If the rope dallies around the horn, the contestant may undally the rope and then stop the horse to make the rope break away.
- Any part of the pusher breaking the plane of the chute before the calf releases the barrier.

### **Calf Roping**

The time limit is 30 seconds. All penalties will be assessed after the run. There shall be two or more timekeepers, a tie or field judge, a barrier judge and as many other officials as the local management finds necessary.

### Tack & Equipment

- A secure neck rope, strap, or rope latch is required for tie-down calf roping.
- Two loops will be permitted if carried. Should the roper miss with both, he must retire and no time will be allowed. A contestant must adjust rope and reins in a manner that will prevent his horse from dragging the calf.

### Class Rules

- Animals used for this event should be inspected and eliminated if objectionable.
- If there must be a re-run of calves to complete a round, all calves must be tied down before any stock is drawn. If after one go-round has been completed a fresh calf has to be used, the calf must be roped and tied down before the drawing. If extra calves have been tied, they will not be considered fresh.
- Contestant must receive no assistance after crossing starting line. If a horse drags the calf, the field judge may stop the horse and flag judge can assess any penalty for such an offense.
- Catch as catch can rule – Any catch is legal.
- The rope must be tied hard and fast.
- Contestants must dismount, follow the rope, throw the calf by hand, and cross and tie any three feet. If the calf is down when the roper reaches it, the calf must be stood on at least three feet (calf may be helped by roper, but at least three feet must dangle straight under calf) and then be re-thrown by hand. If the roper's hand is on the calf when it falls, the calf is considered thrown by hand.
- The rope must hold until the roper gets his hand on the calf.
- A legal tie requires at least one complete wrap around at least three legs and a half hitch or hooey. A hooey is a half hitch with a loop.
- A stopwatch will be used by the field judge. The calf must stay tied for six seconds and three legs must remain crossed. The judge will start timing after the roper has remounted and the horse has taken one step forward. If the rope is not on the calf when the roper begins the tie, the six-second time limit will start when the roper clears the calf. Tie must hold until passed on by judge. If the tie comes loose or the calf gets to its feet before the tie has been ruled a fair one, no time will be marked. Untie man must not touch the calf until the judge passes on the tie.
- If the field judge flags out a roper that still legally has one or more loops coming, the judge may give the same calf back, lap and tap, plus time already lapsed and any barrier penalties. If time was not recorded, the contestant will receive a 10-second penalty for any loop used. Contestant will only be granted remaining loops, not additional loops.

### Penalties

The judge will not flag the contestant out until time is recorded. The judge is to flag time and then flag the contestant out if the run is not legal. A 10-second penalty will be given for beating or breaking the barrier.

The following actions will result in a no time/disqualification:

- Not releasing the rope from the hand when roping the calf.
- Abusive treatment of calf or horse, including but not limited to intentional and excessive dragging.
  - Intentional dragging is caused by the contestant.
  - Excessive dragging is defined as moving the calf more than six feet after the contestant has called for time.
- Touching calf, string, or rope to train horse after contestant has mounted horse.

- Any part of the pusher breaking the plane of the chute before the calf releases the barrier.

### **Dally Team Roping**

The time limit is 45 seconds. All penalties will be assessed after the run. There shall be two timers, a barrier judge, and a field flag judge, with the time to be taken between the two flags. Arena conditions will determine the score. The length of score is to be set by the arena director and time event director or spokesman, if present.

Animals used for this event should be inspected and eliminated if objectionable.

### **Tack & Equipment**

Dally team roping contestants must have saddle horns wrapped from base to cap with a firm material that will withstand the pressures of the dally. The horn wrap functions to provide traction to keep the dally from slipping and burning the hand or severing fingers and/or thumbs. Slick or unwrapped saddle horns are prohibited.

The most widely used wrapping is a wide band of rubber cut from an inner tube looped around the horn, stretched, and twisted and then looped back around the horn until a firm, uniform covering is achieved.

Each contestant is allowed to carry only one rope. No tied ropes allowed.

### **Class Rules**

- All changes in lists of roping order to split horses, etc., must be made before any stock is loaded into the chutes. Once stock is loaded, a roper must rope in the order listed.
- Header will start behind a barrier and must throw the first loop at the head.
- Heeler must start from behind the barrier line.
- Time will be taken when the steer is roped and both horses are facing the steer in line with ropes dallied and tight. Each horse's front feet must be on the ground.
- Each team is allowed three total throws.
- Roper must dally to stop steer or change steer's direction.
- A 'dally' requires one complete turn around the horn.
- Both ropers must be mounted when time is taken.
- Steer must be standing up when roped by head or heels.
- No foul catches can be removed or adjusted by hand.
- If the field judge flags out a team that legally still has one or more loops remaining, the judge may give the same steer back, lap and tap, plus time already elapsed and any barrier penalties. If time was not recorded, a ten-second penalty will be assessed for each loop already thrown. Contestant will only be granted remaining loops, not additional loops.
- There will be 4 legal catches:
  - o Both horns.
  - o Half a head.
  - o Around the neck.
  - o Heeler only – Any heel catch behind both shoulders if the rope goes up the heels.

### **Penalties**

The judge will not flag the contestant out until time is recorded. The judge is to flag time and then flag the contestant out if the run is not legal.

- A 10-second penalty will be given for beating or breaking the barrier.
- A 5-second penalty will be given for catching only one hind foot.
- The following actions will result in a no time/disqualification:
  - Not releasing the rope from the hand when roping the steer.
  - Abusive treatment of steer or horses.
  - The rope is dropped or broken.
  - Any part of the pusher breaking the plane of the chute before the calf releases the barrier.
  - The front foot of the steer being in the header's loop when the header dallies and switches direction.
  - Heeler roping one or both front hooves in the heel loop. \*If the hooves fall out of the loop by the time the field judge drops the flag, time will be counted.
  - The heeler roping the steer before it is turned and moving forward. A heel loop thrown in the switch is called a cross-fire and is illegal.
- Illegal catches:
  - o Hondo passes over one horn loop over the other.
  - o Loop crosses itself in the head catch (figure eight).

### Qualification/Partner

A dally team roper can attempt to qualify once, but may rope a second time to help another person qualify. However, they must use their first qualifying attempt results as their basis for qualifying for the State 4-H Horse Show. The roper must qualify at an official county 4-H Horse Show to enter the event at the State 4-H Horse Show. Contestants may only attempt to qualify with other 4-H members officially entered in the team roping. A parent, adult volunteer/leader or Junior 4-H Member will not be allowed to participate. Violation of this rule will result in disqualification.

State 4-H Horse Show – If there is only one dally team roper or an odd number of dally team ropers from a county, they can partner with a team member from another county who has qualified for State Horse Show. The new partner must count this as an event for the State 4-H Horse Show.

### **Youth In Action**

All youth participating in horse Youth in Action events must be enrolled in the horse project and complete Youth HORSE Training annually. Western or English style attire for all Youth in Action events will be accepted.

### **State 4-H Horse Youth In Action Awards**

Top three teams and top five individuals will be awarded in the State Hippology, Horse Judging, and Horse Quiz Bowl contests. In the Horse Public Speaking, Individual Demonstration, and Team Demonstration contests, top five will be recognized.

### National Contest Eligibility

Only senior 4-H members age 14 to 19 (as of January 1 of the current 4-H year) are allowed to participate in national competition.

All contestants must be members of 4-H in the state they are representing during the year in which the National 4-H Competitive Event is held. The January dates for the Western Horse Classic event are considered part of the previous year for the purpose of allowing all youth to compete in the national horse events in their last year of eligibility.

All participants must first qualify through the represented state and meet all the state eligibility rules. States are invited to enter one (1) team of no more than four members. On teams consisting of four members, all will compete; however, the lowest score in each phase will be dropped. For those teams consisting of three members, all members' scores will count in determining individual and team awards.

- Contestants (including team alternates) may participate in only one national contest (i.e. quiz bowl, judging, hippology, etc.) per year.
- After competing in a national contest, contestants (including team alternates) are ineligible to compete in the same contest again at the national level.
- The contestant, his or her county 4-H staff member, and the State 4-H Leader must certify as follows on the application form or an accompanying memo:  
This contestant has not participated in postsecondary coursework in the subject area of the national competition, nor has he or she participated in training for post-secondary competition in the subject area of the national 4-H competition.”  
The following competitive events are available for senior 4-H members:
- National 4-H Hippology Contest – the top Senior Hippology team members will be eligible to represent South Dakota at the Western National 4-H Roundup in Denver, Colorado provided the top team's score is at least 60% of the total points possible.
- National 4-H Horse Judging – Top four individual Senior horse judges will be eligible to represent South Dakota at the Western National 4-H Roundup in Denver, Colorado provided the top team's score is at least 60% of the total points possible.
- National 4-H Horse Quiz Bowl – the top Horse Quiz Bowl team that consists of four Senior members will be eligible to represent South Dakota at the Western National 4-H Roundup in Denver.
- National 4-H Public Speaking Contest – the top Senior receiving a purple in public speaking at the State 4-H Horse Show will be eligible to represent South Dakota at the Western National 4-H Roundup in Denver, Colorado.
- National 4-H Individual Demonstration Contest - the top Senior receiving a purple in individual demonstration at the State 4-H Horse Show will be eligible to represent South Dakota at the Western National 4-H Roundup in Denver, Colorado.
- National 4-H Team Demonstration Contest - the top Senior receiving a purple in team demonstration at the State 4-H Horse Show will be eligible to represent South Dakota at the Western National 4-H Roundup in Denver, Colorado.

## State 4-H Hippology Contest

Hippology is an activity that can make learning fun for 4-H members, by letting them exhibit their knowledge and understanding of equine science and husbandry in a friendly but competitive setting.

### Teams

- Each county may enter unlimited senior and junior teams. Each team must consist of no less than three and no more than four members. Reminder: Only Senior contestants will be eligible for National Competition.
- Each Senior team must be made up of 3-4 seniors.
- If a county team cannot be fulfilled, a county may join with any other county that cannot fulfill a team to make a joint county team.
- Contestants (including team alternates) that have participated in the Hippology National Contest may only compete as individuals in the State Hippology Contest.

### The Contest (4 Phases)

**Examination Phase** – may include but not limited to:

- Written Exam
- Projected slides to be identified as to breed, color, color pattern, activity, proper appointments, etc.
- Anatomy which may include external, skeleton, internal organs, parts of gastrointestinal tract, male and female reproductive organs, detailed anatomy of the foot and detailed lower limbs.

**Station Phase** – this phase will consist of a series of stations or tables where all contestants will respond to the requirements of the station. Members will be allowed two minutes at each station. Examples of stations which may be used but not limited to:

- Identification of:
  - Various types of saddles (actual or pictures) and parts of saddles.
  - Tacks, bits, bridles, horse shoes and parts of shoes. Tools and equipment, and assembly of specific parts of various pieces of equipment. Grains and forages used in equine rations including various forms of methods of preparation.
  - Internal and external parasites based on actual samples, pictures, life cycle charts and /or damage caused.
  - Blemishes and unsoundnesses.
  - Age of equines based on teeth.
- Use of pulse rate, respiration rate, temperature, dehydration, anemia, etc., to assess horse health.
- Measurements such as, but not limited to, wither height, shoes size, girth, collar size, gullet width, seat length of saddle, etc. may be required.

**Judging Phase** – contestants will be required to place at least two classes, consisting of one halter and one performance.

**Team Problems Phase** – Each team will be presented with the same problem(s). They will have equal time to discuss among themselves the problem, immediately after which they will have to present an oral solution or series of suggested procedures relative to the problem.

Each team member is encouraged to participate in the oral presentation. Evaluation will be based on the understanding of the problem, completeness of the response, the probability of success of the solution or procedures, and the logic used in making the oral response.

The official may ask questions of any or all of the team members to clarify the presentation. Team problem scores will not be included in determining the rank of individuals but will be added to the team scores from the other three phases to determine overall team standings. Examples of possible team problems include but are not limited to:

- Balancing a horse's ration.
- Farm management recommendations for specific horse operations (i.e. breeding, training, boarding, nursery, lay-up, etc.).
- Considerations for the establishment of a new horse facility (stable to be used for a specific purpose).
- Recommendations for selecting, locating, and purchasing horses for specific uses.
- Behavior problems—causes, management of and corrections.
- Training and conditioning programs—equipment, schedules, methods, nutrition, and problem avoidance.
- Breeding and /or leasing contracts—specific clauses for insurance, liability, payments, care, termination, transport, etc.
- Teaching lessons in horse management (specific subject to be announced) to a group of 9-11 year old beginner participants: where, how long, how much information, hands-on experience, reinforcement, testing evaluation, will be considered.
- Explanation of use or assembly of specific equipment.
- Demonstrate skill or ability to use specific equipment.

## **Tie Breaking**

All ties overall, individual and team, will be broken using the following sequence:

1. Examination scores
2. Station scores
3. Judging scores

Ties within any phase are to be broken using the overall score first and then the same sequence as above. If further tie breaking is needed, the scores at each station, in order, may be used.

## **Resources**

- IDET Illustrated Dictionary of Equine Terms - New Horizons Equine Education Center. Alpine Publications, PO Box 7027, Loveland, CO 80537 Phone: (800) 777-7257
- Evans The Horse - Evans, Borton, Hintz, and Van Vleck. Second Edition. W. H. Freeman and Company, 660 Market Street, San Francisco, CA 94104 Phone: (415) 391-5870
- Lewis Feeding and Care of the Horse - Lon Lewis Williams and Wilkins. Second Edition. 351 West Camden Street, Baltimore, MD 21201-2436 Phone: (800) 638-0672
- HHH Horse Industry Handbooks and updates - American Youth Horse Council; 1 Gainer Rd, McDonald, NM 88262 Email: info@ayhc.com Phone: 817.320.2005 Web: <http://www.ayhc.com/shop>
- HS Horse Smarts - American Youth Horse Council; 1 Gainer Rd, McDonald, NM 88262 (available spring 2017) Email: info@ayhc.com Phone: 817.320.2005 Web: <http://www.ayhc.com/shop>
- AQHA AQHA Rulebook: 2017 65th edition <http://aqha.com/handbook> Only show rules will be used (SHW300-SHW712).
- Parker Equine Science – Rick Parker. Fourth edition. ISBN-13: 9781111138776; Published January 2012
- Grains, forages, and feed preparations used in this contest will be representative of feeds utilized in horse rations.

## **State 4-H Horse Judging Contest**

- Teams - A county can enter an unlimited number of county teams. But once entered there can be no changes to a team. County teams consist of three no more than four members. If a county does not have enough members to fill a team within an age division, those one or two individuals are still eligible to judge and compete for individual awards.
- Individual who have competed in the National Horse Judging contest may compete as individuals at the State Horse Judging Contest.
- An unlimited number of individuals from a county can judge at the South Dakota State 4-H Horse Judging Contest. They must meet entry deadline; no late entries will be accepted.
- If a county team cannot be fulfilled, a county may join with any other county that cannot fulfill a team to make a joint county team. Reminder: Only Senior contestants will be eligible for National Competition.
- It is the responsibility of the 4-H Youth Program Advisor or county coaches to verify team and individuals are accurate during contest registration.

## **The Contest**

All classes will be comprised of four horses and be designated with numbers 1 – 2 – 3 – 4. Contestants will be allowed 10-12 minutes per class to make their observations, take notes, and fill out their placing card.

Contestants will be divided into groups for the contest and will remain with their assigned group throughout the contest. While the contest is in progress, there is no conferring between contestants. Offending contestants may be disqualified.

Two minute time limit will be allowed to give oral reasons for those classes indicated as oral reasons classes. Reasons will be given at the completion of judging all classes. Contestants will be given time to review notes and prepare reasons. Contestants are not permitted to use notes while giving oral reasons or completing questions.

**Senior Contest** - The senior contest will be comprised of four halter classes and two performance classes based on availability. Reasons will be given on two halter classes and one performance class.

**Junior Contest** - The junior contest will be comprised of four halter classes and two performance classes based on availability. Reasons will be given on two halter classes.

**Beginner Contest** – The beginner contest will be comprised of four halter classes. Questions will be given on two classes. A horse body parts identification quiz will be given.

### **Halter Classes**

Four animals of the same sex and breed will be used. The following breeds may be represented in the halter classes: American Saddlebred, Quarter Horse, Appaloosa, Arabian, Paint, Morgan, Draft Breeds, and Miniature Horses. Emphasis in class selection is given to conformation differences rather than size or bloom. Classes will depend on availability of animals for use. All halter horses are to be judged as sound of limb, eye, wind, mouth, and reproductive organs.

### **Performance Classes**

Any bona fide 4-H performance class may be used, depending on availability. The performance classes will be chosen from Trail, Western Pleasure, English Pleasure, Hunter Under Saddle, Hunt Seat Equitation, Saddle Seat Equitation, Ranch Riding, Western Riding, Reining, Western Horsemanship, and Hunter Hack. Performance horses will be judged as seen (unsoundness to be penalized accordingly).

### **Suggested Halter Class Judging Procedure**

Procedure may be altered to fit specific situations, contests or events.

1. Contestants all keep their backs to the class until the signal to begin from the announcer.
2. Twenty-five foot line – all contestants must stay behind this line until the horses are traveled.
3. Space horses about eight feet apart on level ground.
4. Number on showman – left to right – 1, 2, 3, 4.
5. Begin with a side view.
6. Move the horses one-quarter turn (90 degrees) at 1½ minute intervals.
7. Left side – rear - right side – front.
8. Announcer will indicate the rotation of the class horses and group leaders will see that the instructions are carried out.
9. Start with the #1 horse, walk both ways and trot both ways. Lead on a straight line between groups observing travel. The group leader will see that all horses are set up and moved properly.
10. After all four horses have been observed on the move, allow close inspection at rear view. No touching or mouthing horses. CAUTION – stay one horse length away to avoid being stepped on or kicked. Exception: to check height of horse, approach from the left side.
11. Final view – all contestants behind the 25 -foot line, side view, and mark card in final two minutes.
12. Contestants check placing and hand cards in to their group leader. NO TALKING or SIGNALING is allowed as groups are changing classes. Move groups clockwise and around the class in such a manner that groups do not intermingle.
13. DO NOT move to next class until instructed by the announcer.

### **Suggested Performance Class Judging Procedure**

1. Contestants and official judges are to be seated in the bleachers.
2. Announcer calls the class routine and line-up.
3. Reining classes perform in order of assigned number – 1, 2, 3, 4.
4. Class participants should line up after each individual performance, left to right - 1, 2, 3, 4 - for clarification of numbering of contestants.
5. Equitation classes enter and proceed with regular class routine, ending with horses lined up, left to right - 1, 2, 3, 4 - at ring center.
6. Due of close proximity of contestants, look straight ahead, NO TALKING.

### **State 4-H Horse Quiz Bowl**

The objectives of this activity are to stimulate learning and provide an opportunity for youth to demonstrate their knowledge of equine-related subject matter in a competitive setting with attitudes of friendliness and fairness. These contests will provide an educational experience for both participants and spectators. The contest is open to all 4-H members, including those who may not own a horse. The South Dakota 4-H Horse Quiz Bowl competition will follow the National Contest process and procedures.

### **Teams**

- To participate in the South Dakota State 4-H Horse Quiz Bowl Contest, the participant must be a current 4-H member. Reminder: Only Senior contestants will be eligible for National Competition.
- Contestants that have participated in the National Quiz Bowl contest are not eligible to compete in the South Dakota State 4-H Quiz Bowl Contest.
- Each county may enter as many teams as they wish. Each team must consist of no less than four and no more than five members. Senior teams must be made up of only Seniors. Juniors are not allowed on Senior teams.
- If a county team cannot be fulfilled, a county may join with any other adjoining county that cannot fulfill a team to make a joint county team.

### The Contest

Only 4 contestants may be seated on the panel at any one time. One team member may be replaced on the panel when:

- The moderator deems it impossible for one of the seated members of the team to continue in the contest.
- The captain or coach of a team requests the replacement of a team member.
- The removed team member may not return to that particular match.

There may be only one coach designated during any given round. The coach and alternate of a team should sit in the designated area. Coaches will not be allowed in the holding room during rounds.

### Questions

There will be three types used:

- One-On-One questions to which individual contestants may respond. These points will count toward individual and team scores.
- Toss-Up questions are open to response by all contestants. These points will count toward individual and team scores. Three toss-up questions will have a bonus question attached and in general will be somewhat more difficult.
- Bonus questions are given to the team whose member has just correctly answered a toss-up question. The team is given 10 seconds to confer on this question which usually has more than one part. All parts of the bonus question must be answered before any points will be awarded. These points will count toward a team score. Only one member of the team will answer, however other team members may feed information to the individual answering.

### Match Procedures

NOTE: The number of questions will decrease at the South Dakota State 4-H Horse Quiz Bowl Contest due to time constraints. All other rules will follow National Quiz Bowl Guidelines.

- Each match will be divided into two parts based on number of questions (40 questions per round plus 3 bonus questions).
- In the first part of the match, during the one-one-one competition, only one member of each team will be eligible to respond to a question. This eligibility will rotate with each question beginning with the number 1 players on each team, and passing to the number 2, 3 and 4 contestants of each team, respectively, until all the one-on-one questions have been asked. The number of questions asked during the first part of the game should be evenly divisible by 4 to assure each team member an opportunity to respond to the same number of questions (i.e. 20 questions).
- During the second part of the match any individual on either team may respond to a question (20 total questions).
- After being recognized by the moderator, the contestant activating the buzzer shall have five (5) seconds to begin the answer to the question. If the buzzer is activated during the reading of any question, the moderator immediately will cease reading the question.
- The moderator will continue reading questions (and bonus questions if applicable) until all questions have been asked.
- If a question is thrown out either due to poor reading by the moderator or a decision of the referee judges, it will be replaced by another question so that the total number of questions to be asked remains consistent.
- Either team captain or coach, or the moderator may call for a "time out" for clarification of a rule, to permit replacement of a team member, or to allow for unexpected problems. These "time outs" may be called only after a question has been answered and before the start of the next question.
- The protest of a question or answer to a question may be made only by a team captain or coach and then only at the time a particular question is read or the answer is given. The moderator and the referee judges will consider the protest, and their decision in all cases is final.

### Resources

- Illustrated Dictionary of Equine Terms – New Horizons Equine Education Center. Alpine Publications.
- The Horse, 2nd Edition – Evan, Borton, Hintz, and VanVleck. W.H. Freeman and Company.
- Feeding and Care of the Horse, 2nd Edition – Lon Lewis. Williams and Wilkins. 70
- Horse Industry Handbook – American Youth Horse Council; PRIMEDIA Equine
- Horse Smarts – American Youth Horse Council
- AQHA Handbook, 65th Edition – Only show rules will be used, SHW300-SHW750. [www.agha.com/handbook](http://www.agha.com/handbook)
- Equine Science, 4th Edition – Rick Parker

Please reference the National Western Roundup website, Horse Classic section, for more detailed contest information.

## Scoring

Only those contestants who have participated in three or more matches at the State contest will be considered for the top individual awards. The three high match scores for each individual will be used in cases where individuals participate in more than three matches. Ties for individual awards will be broken on the basis of: first, high average score for the entire contest; second, high individual match scores; and third, total number of points earned.

## Quiz Bowl Scoring System

	<b>Correct</b>	<b>Incorrect</b>
One-on-One Questions	+ 2 points	-1 point
	Contestant other than the two designated contestants responds: -2 points	
Toss-up Questions	+1 point	-1 point
Bonus Questions	+3 points	No deduction
Failure to signal or contestant not acknowledged by moderator		-1 point
Protest not upheld		-1 point

## State 4-H Horse Public Speaking Contest

### Contest Rules

- The subject matter must pertain to the horse industry. Speeches not appropriately related to the horse industry can be disqualified at the discretion of the judge(s).
- No visual aids may be used, including the use of handouts such as bibliographies and pamphlets. Contestants will be disqualified for using any visual aid, including handouts, prior to, during, or after the speech.
- Contestants may use notes. However, excessive use of notes may be counted against the contestant. This will be at the discretion of the judges.
- A public address system will not be used, but a podium will be provided.
- During the competition the contestants may introduce themselves by name, state, and speech title.
- Speeches should be 7-10 minutes in length. One point will be deducted from the total score for each minute or fraction of a minute under 7 minutes or over 10 minutes by each of three judges for a three points per minute total deduction. After the individual has been introduced by the superintendent, the time will start once the contestant begins to speak.
- Contestants should cite their major reference materials at the end of the presentations. This time will not be counted in the allotted time.
- Only the judge(s) may ask questions of the contestant. Question time will not be counted in the allotted time. Contestant should repeat the question then answer it.
- Contestants will sign up for a time to give their presentations at the State 4-H Horse Show Office located in the Beef Complex.
- Ties will be broken by:
  - o first, the judges accumulated delivery score
  - o second, the judges accumulated organization score
  - o third, on content and accuracy scores
- For educational purposes the management may videotape all speeches with individual consent.



### Judge's Suggested Scoring System

100 points possible (Judges will consider the questions listed under each section)

10 points	Introduction	Did the introduction serve to create interest in the subject?
		Was the introduction short and concise?
15 points	Organization	Were the main points easy to follow?
		Were the main points arranged in the best order?
		Were the sentences short and easy to understand?
		Was the speech interesting?
20 points	Content & Accuracy	Were facts and information accurate?
		Was there enough information concerning the subject?
		Was credit given to sources of information if appropriate?
		Was content appropriately related to the horse industry?
15 points	Stage Presence	Was the speaker neat and appropriately dressed?
		Was the speaker friendly?
		Did the speaker talk directly to the audience?
		Did the speaker look at the audience?
		Was posture erect but not stiff?
		Did the speaker refrain from leaning on the podium?
		Did the speaker seem relaxed?
20 points	Delivery	Did the speaker have appropriate voice control?
		Were all words pronounced correctly?
		Did the speaker's facial expression reflect the mood of the speech?
		If notes were used, was it done without detracting from the speech?
		Did the speaker seem to choose words at the time they were used? (not memorized)
10 points	General	Did speaker convey to the audience a sense of wanting to communicate?
		Did speech reflect the thoughts and personality of the speaker?
10 points	Conclusion	Was the conclusion short and interesting?
		Did the conclusion properly summarize the speech?
		Could the speaker handle questions easily?

### **State 4-H Horse Demonstration Contest**

#### **Individual & Team Contest Rules**

- The subject matter must pertain to the horse industry. Demonstrations or presentations not appropriately related to the horse industry can be disqualified at the discretion of the judge(s).
- Presentations may be either of demonstration or illustrated talk format. No live animals may be used.
- Contestants may use notes. However, excessive use of notes may be counted against the contestant. This will be at the discretion of the judges.
- A public address system will not be used in the contest.
- Creative audio visual aids may be used, but the contestants must be involved in making or designing them.
- During the competition, the contestants may introduce themselves by name, state and presentation topic.
- Presentations should be 10-15 minutes in length. One point will be deducted from the total score for each minute or fraction of a minute under 10 minutes or over 15 minutes by each of three judges, for a three-points per minute total deduction. After the individual or team has been introduced by the superintendent, the time will start once the contestant(s) begin(s) to speak.
- Contestants should cite their major reference materials at the end of the presentation. This time will not be counted in the allotted time.
- Only the judge(s) may ask questions of the contestant. Question time will not be counted in the allotted time. Contestant should repeat the question, then answer it.
- Contestant will sign up for a time to give their demonstration at the State 4-H Horse Show Office.
- For educational purposes the presentations may be video recorded with individual or team consent.





- Once an individual or team has started the demonstration (in this case it is after they have been introduced by the superintendent), they may not receive assistance from any coach, parent, audience member, or other person, which includes, but is not limited to, the stroking of any key on a computer or other audio visual device. The penalty for violating this rule is disqualification.
- Ties will be broken by:
  - o first the judges' accumulated delivery score
  - o second by the judges' accumulated organization score
  - o third on content and accuracy scores

**Judge's Suggested Scoring System**



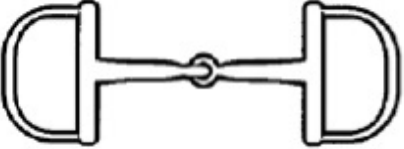

10 points	Introduction	Did the introduction serve to create interest in the subject?
		Was introduction short and to the point?
		Was a catchy title used?
25 points	Organization	Was only one main idea presented?
		Did the discussion relate directly to the step as it was shown?
		Was each step shown or illustrated just as it should be done in an actual situation?
		Could audience see each step?
		Were materials and equipment carefully selected, neatly arranged, and well-organized?
25 points	Content & Accuracy	Were key points of each step stressed?
		Were facts and information accurate?
		Was there enough information concerning the subject?
		Was credit given to sources of information, if appropriate?
		Was content appropriately related to the horse industry?
10 points	State Presence	Were approved practices used?
		Was presenter neat and appropriately dressed for subject of presentation?
		Did presenter speak directly to the audience?
		Did speaker look at the audience?
		Was the presentation too fast or too slow?
15 points	Delivery	Was good teamwork displayed? (Team presentation generally not advisable for one person to do all the talking and the other one all the presenting.)
		Did the presenter appear to enjoy giving presentation?
		Did the presenter have good voice control?
		Were all words pronounced correctly?
		If notes were used, was it done without detracting from speech?
5 points	Effect on Audience	Did speaker seem to choose words at the time they were spoken? (Not memorized)
		Did audience show an interest in the presentation?
10 points	Summary	Could audience go home and carry out the idea?
		Was the summary short and interesting?
		Were the key points briefly reviewed?
		Did the summary properly wrap up the presentation?
		Could presenter handle questions easily?

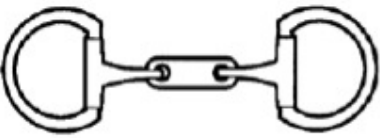
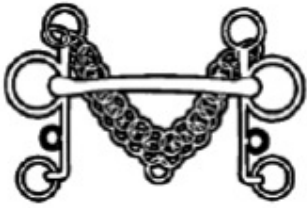
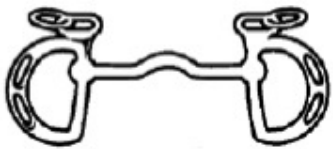
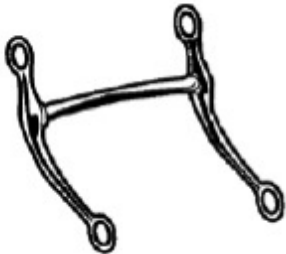
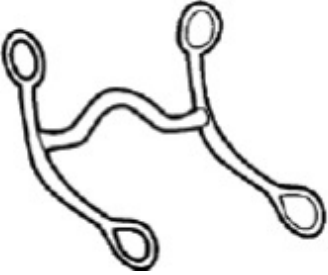
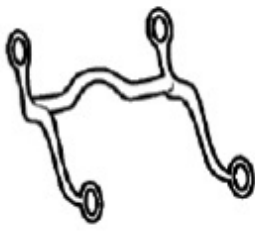
# APPENDIX A

## Legal & Illegal Tack

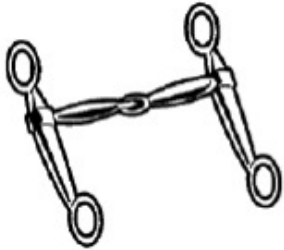
		
<p>1. Gag Snaffle – permissible in speed events only. Must meet mouthpiece standards.</p>	<p>2. Double twisted wire – legal in English classes only.</p>	<p>3. Single twisted wire – legal in English classes only – must meet mouthpiece standards</p>
		
<p>4. Legal D-ring snaffle</p>	<p>5. Legal O-ring snaffle</p>	<p>6. Slow twist – legal in English classes only.</p>
		
<p>7. Legal snaffle – flat piece must meet standards.</p>	<p>8. Pelham with mullen mouth – legal English bit.</p>	<p>9. Legal kimberwick – (English bits).</p>
		
<p>10. Legal curb with mullen mouth (shanks 8" or less).</p>	<p>11. Legal curb with low port and 8" shanks.</p>	<p>12. Legal curb.</p>

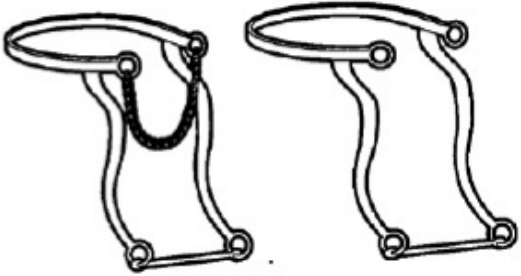
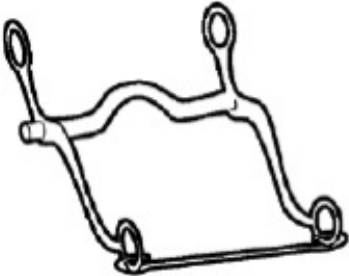
## Legal & Illegal Tack

		
<p>13. Legal curb with broken mouthpiece.</p>	<p>14. Legal curb with roller and 8" shanks.</p>	<p>15. Legal hackamores for speed events (and roping) only. Any wire or chain must be flat and leather or latex covered.</p>
		
<p>16. Illegal curbs - shanks 9" long.</p>	<p>17. Legal curb with broken mouthpiece.</p>	<p>18. Illegal donut bit.</p>

**Examples of Legal Curb Chains & Straps  
(except in barrel racing, pole bending, roping)**

Double link, flat chain – over ½-inch wide leather end straps

Double link, flat chain – over ½-inch wide nylon end straps

Double welded chain– over 1/2-inch wide

Very wide, flattened chain links – Hunt and Polo

Flat nylon – over ½-inch wide

Flat leather over ½-inch wide

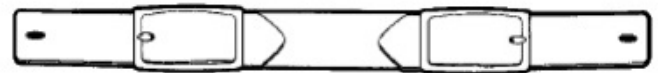
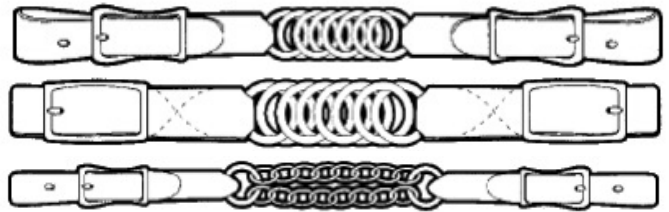

**Examples of Illegal Curb Chains & Straps**

Double link, flat chain – over ½-inch wide nylon end straps

Round leather, too narrow, rounded

Round leather, too narrow at chin and rounded

Double link, flat chain – over ½-inch wide nylon end straps

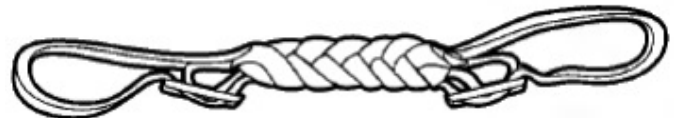

## Legal English Nosebands

Cavesson noseband

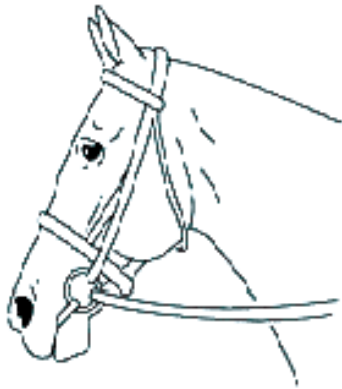

## Illegal English Nosebands

Dropped noseband

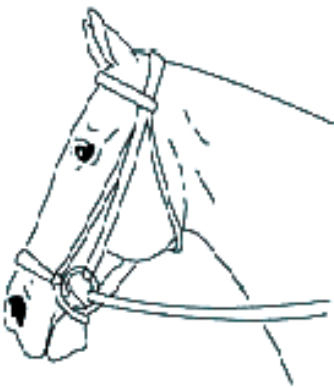

Flashed noseband

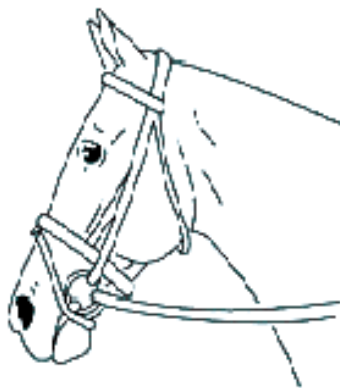

Mexican (crossed figure-8) noseband

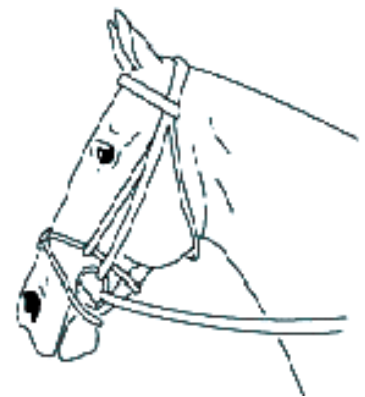

# APPENDIX B

## Patterns



# Barrel Racing Course

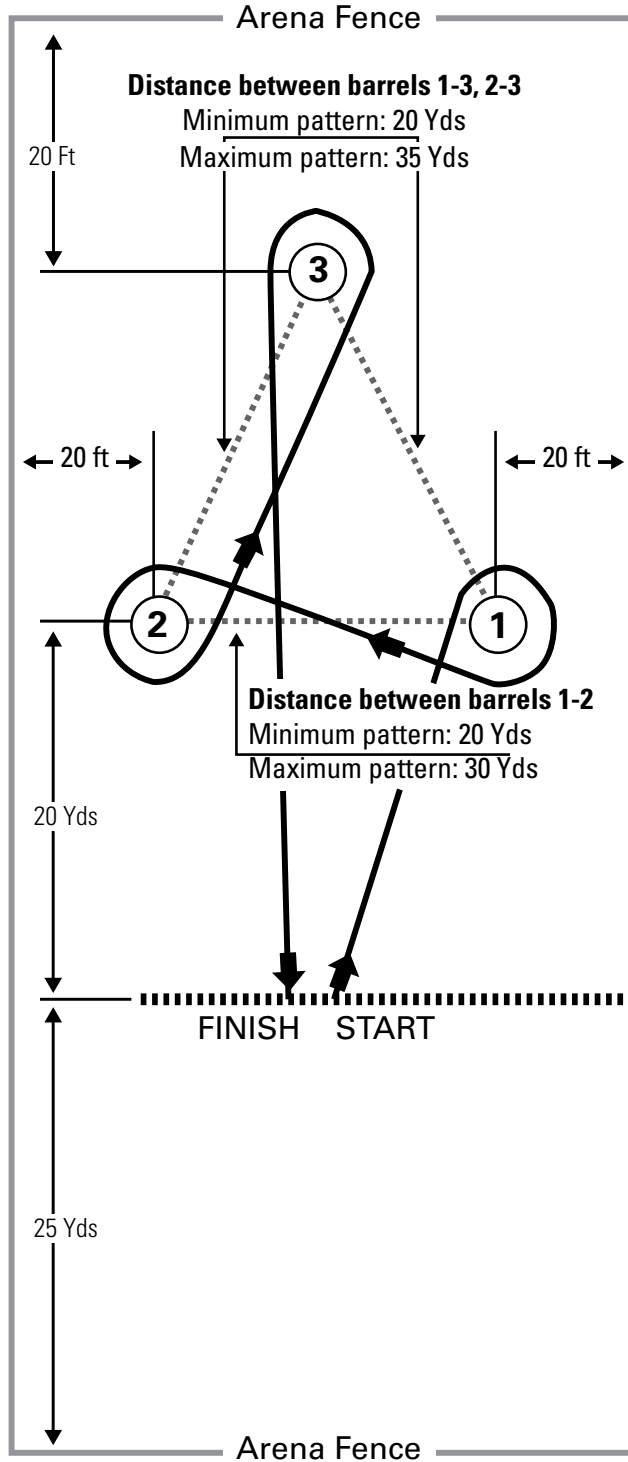

Pole Bending

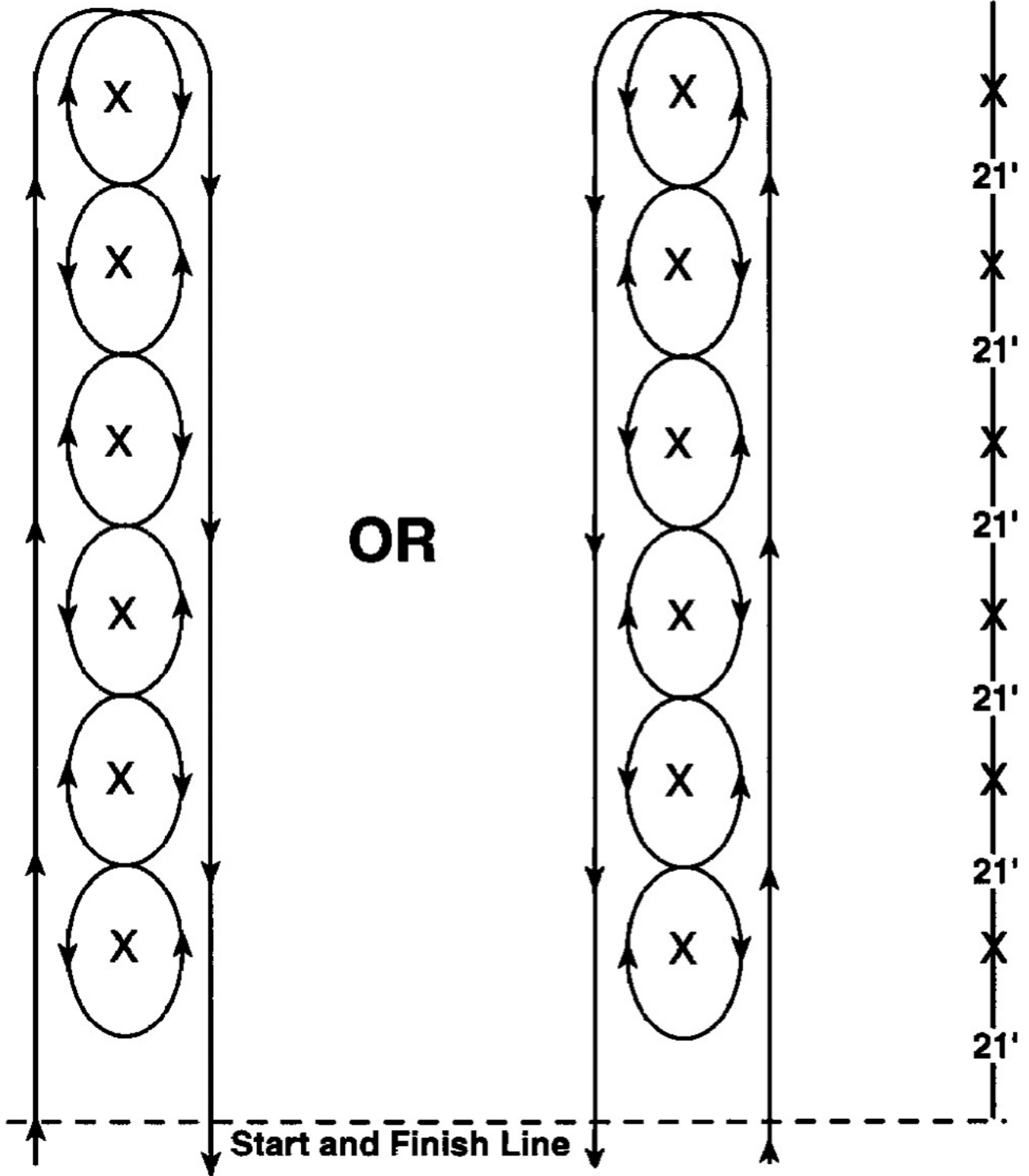

Flag Race

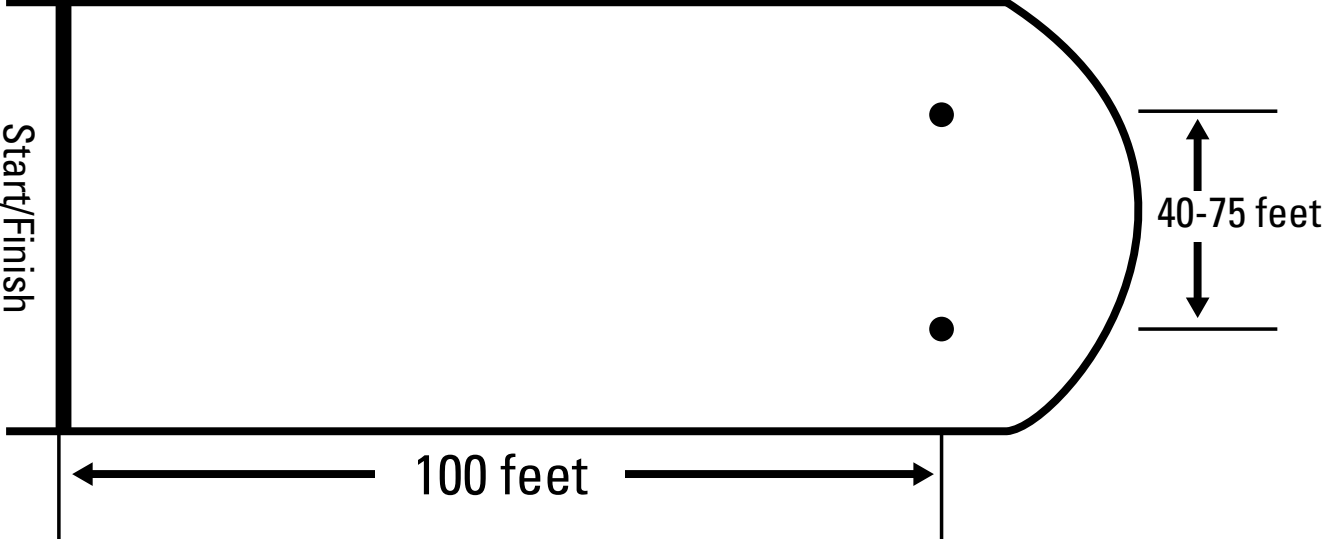

Draft Horse Showmanship Pattern 1

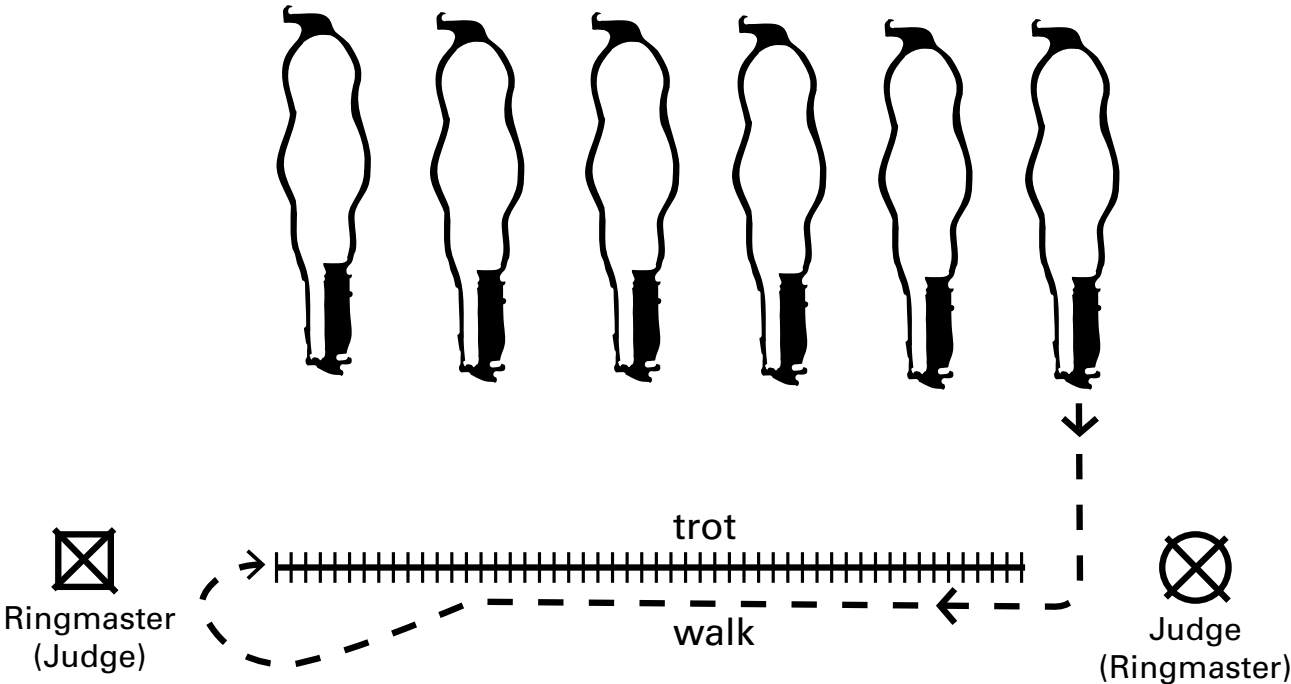

## Draft Horse Showmanship Pattern 2

Produced by Horse Show Patterns.com

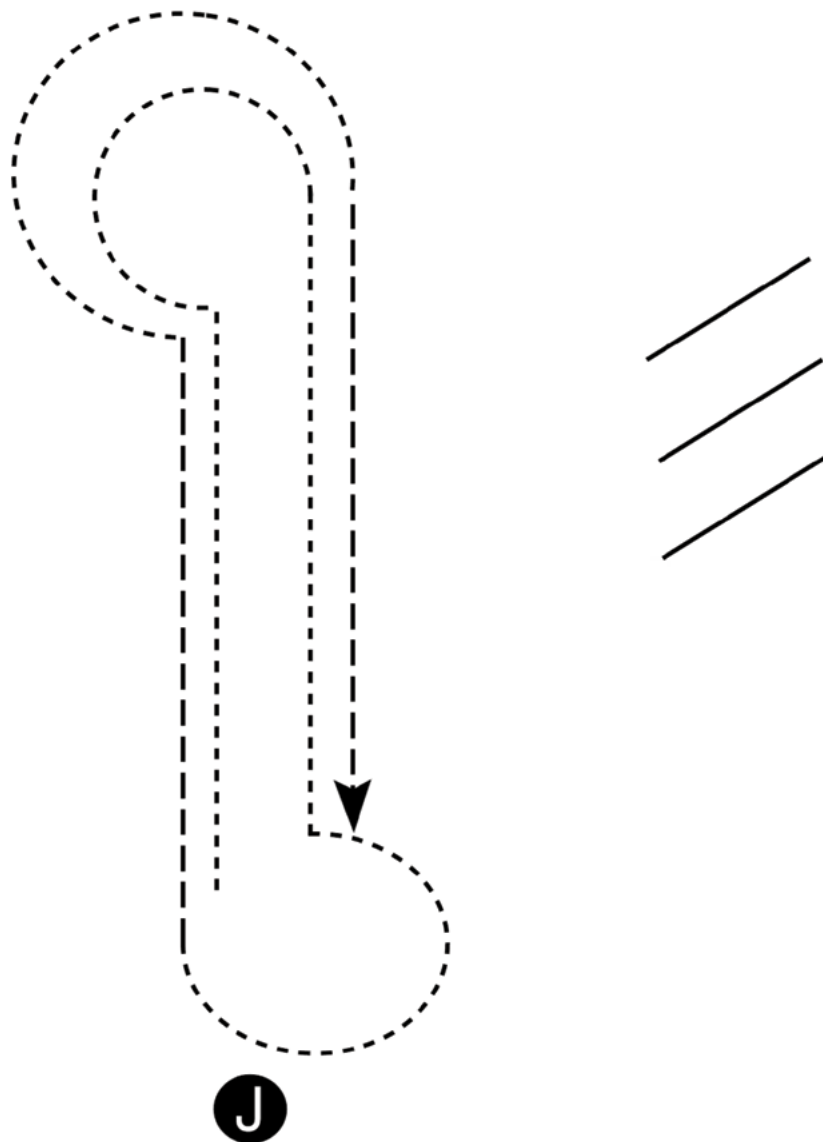

1. From Judge, walk straight away. Walk a "golf club" loop and continue walking towards Judge.
2. Make a "golf club" loop at a walk. When lined up with Judge, trot in a straight line away from Judge.
3. Walk a "golf club" loop and trot the remainder of the way back to the Judge. Set up for inspection (may turn horse 45 degrees either direction.)
4. When dismissed, trot away from Judge.

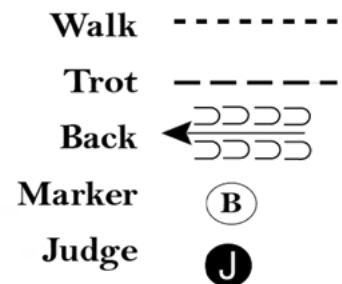

# Western/English Showmanship Beginner/Junior Pattern 1

Produced by Horse Show Patterns.com

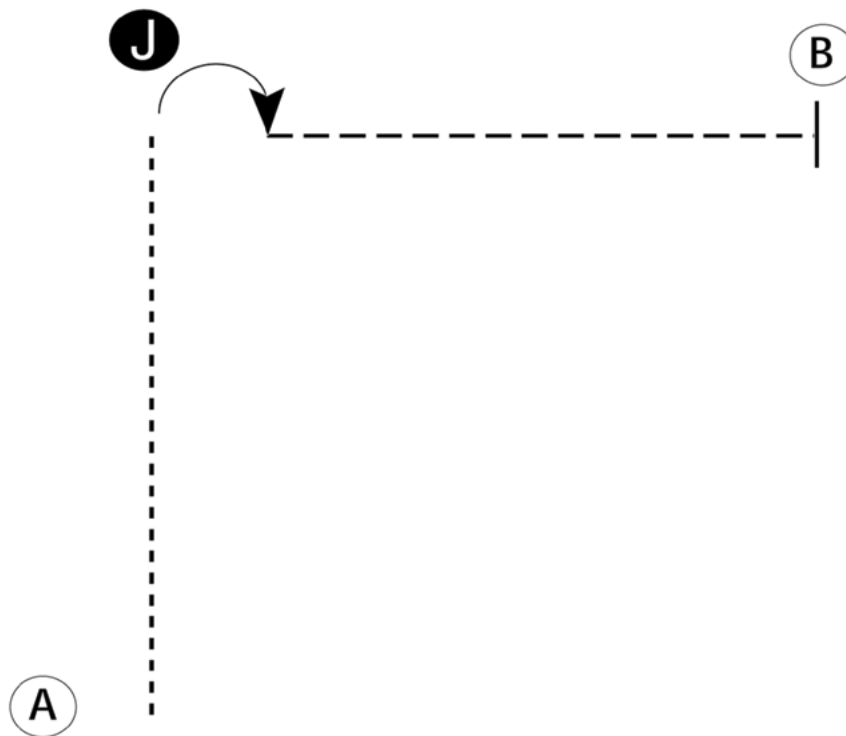

Be ready at A.

1. Walk from A to Judge.
2. Stop and set up for inspection.
3. When dismissed, perform a 90 degree turn.
4. Trot away from Judge to B.
5. Stop at B.
6. Follow the instructions of your ring steward.

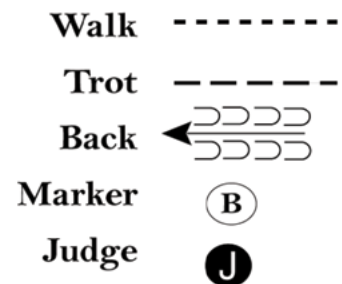

# Western/English Showmanship Beginner/Junior Pattern 2

Produced by Horse Show Patterns.com

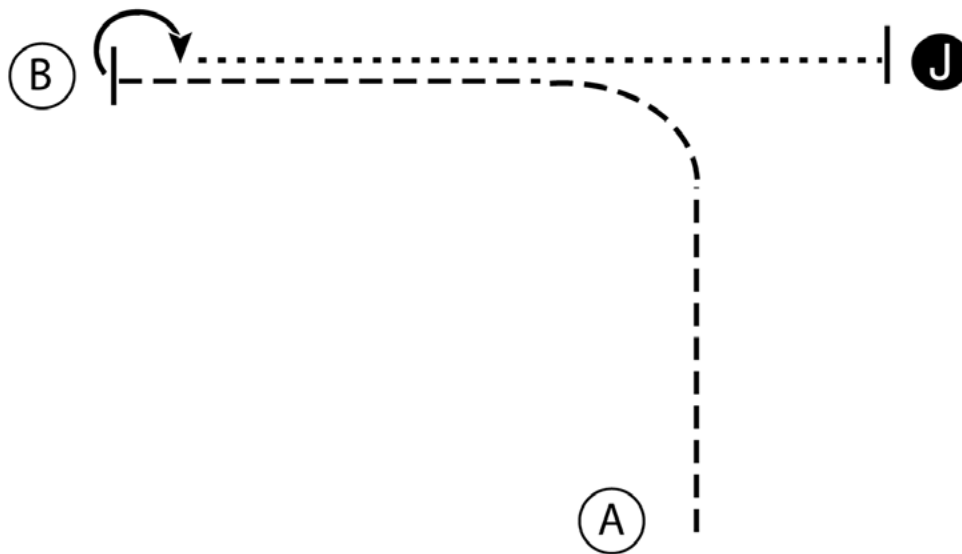

1. Trot from A to B
2. Stop and perform a 180 degree turn.
3. Walk to Judge and set up for inspection.
4. When dismissed follow instructions of ring steward.

Walk - - - - -

Trot - - - - -

Back ←

Marker (B)

Judge (J)

# Western/English Showmanship Beginner/Junior Pattern 3

Produced by Horse Show Patterns.com

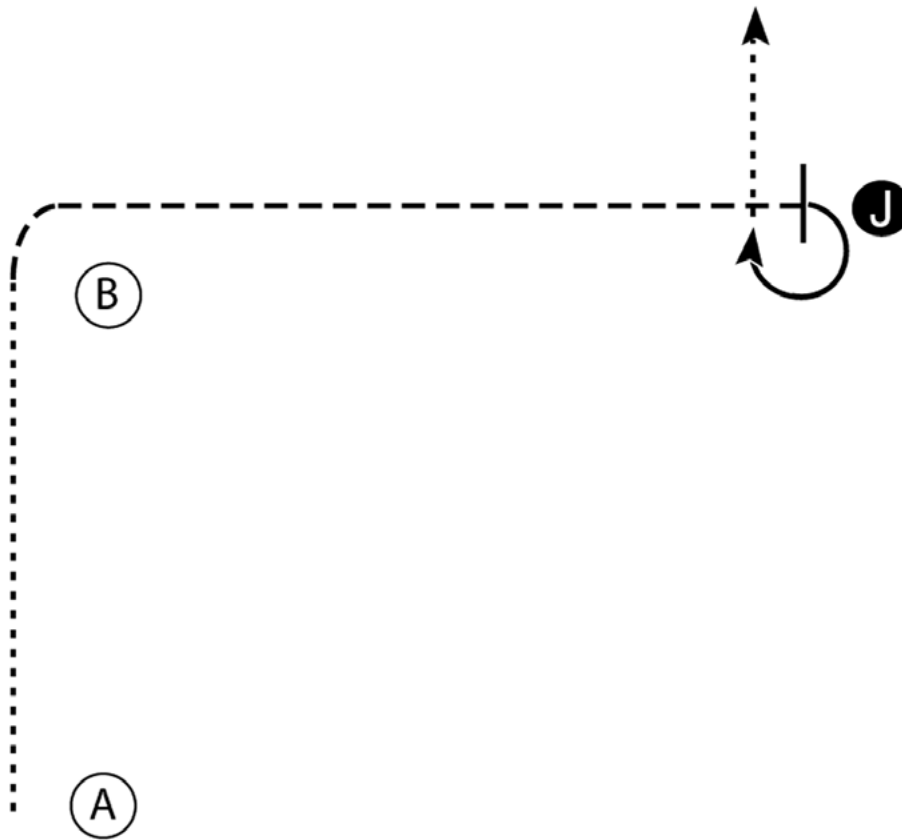



1. Walk from A to B.
2. Trot from B to the Judge.
3. Stop and set up for inspection.
4. When dismissed perform a 270 degree turn and walk straight away from the Judge.

Walk 

Trot 

Back 

Marker 

Judge 



# Hunt Seat/Saddle Seat Equitation Beginner Pattern 1

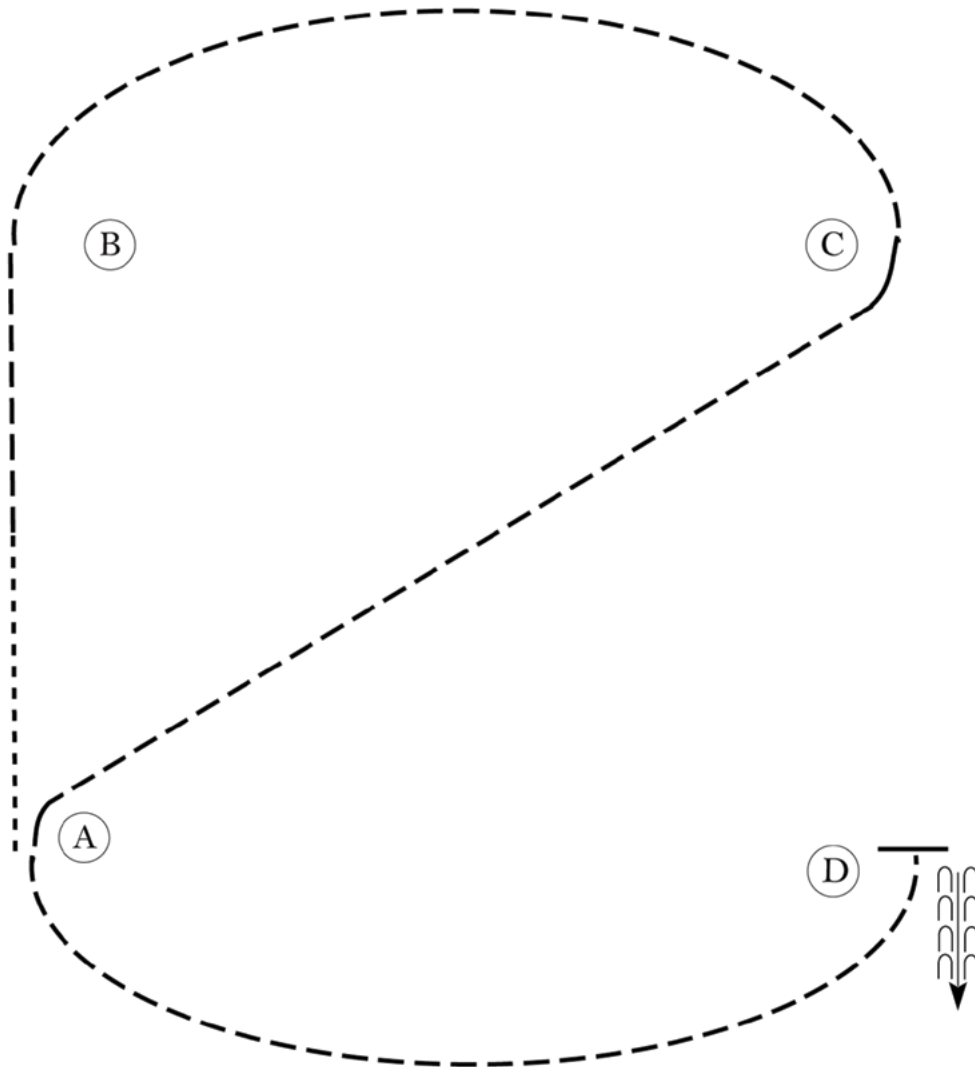

Produced by Horse Show Patterns.com



Be ready at A.

1. Walk halfway to B.
2. Sitting trot to B.
3. Trot on left diagonal from B, to and around C, and halfway to A.
4. Change diagonals halfway to A.
5. Trot on the right diagonal around A and to D.
6. Stop at D and back approximately one horse length.

Walk off and follow the directions of your ring steward.

<b>Walk</b>	-----
<b>Trot</b>	- - - - -
<b>Extended Trot</b>	— — — —
<b>Canter</b>	—————
<b>Lead Change</b>	
<b>Back</b>	
<b>Marker</b>	
<b>Hand Gallop</b>	— — — —

# Hunt Seat/Saddle Seat Equitation Beginner Pattern 2

Produced by Horse Show Patterns.com

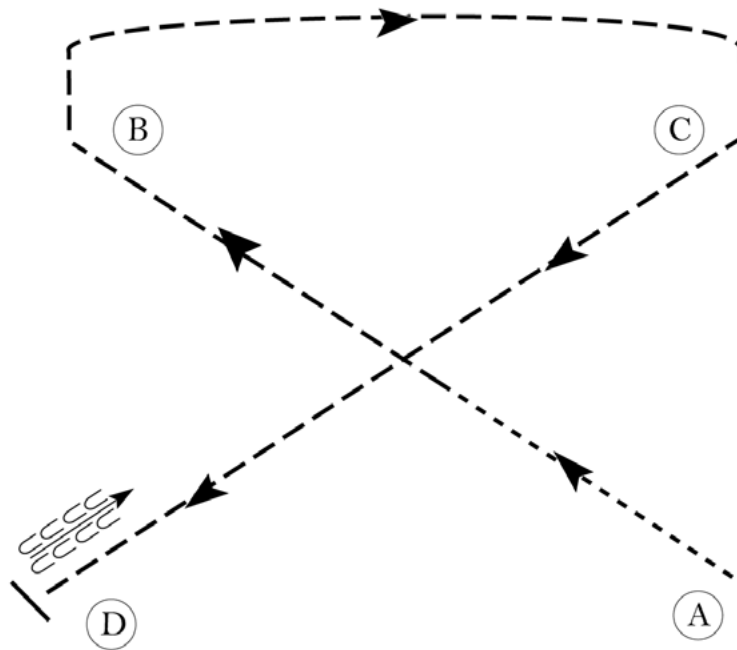

Be ready at A.

1. Walk 1/2 way to B.
2. Posting trot on the left diagonal to B.
3. Sitting trot to C.
4. Posting trot on the right diagonal to D.
5. Halt at D and back approximately one horse length.

Exit at a sitting trot.

Walk	-----
Trot	- - - - -
Extended Trot	-----
Canter	-----
Leg Yield	
Lead Change	↙
Back	←←←←←
Marker	Ⓚ
Sidepass	← - - - - ←
Hand Gallop	-----

# Hunt Seat/Saddle Seat Equitation Beginner Pattern 3

Produced by Horse Show Patterns.com

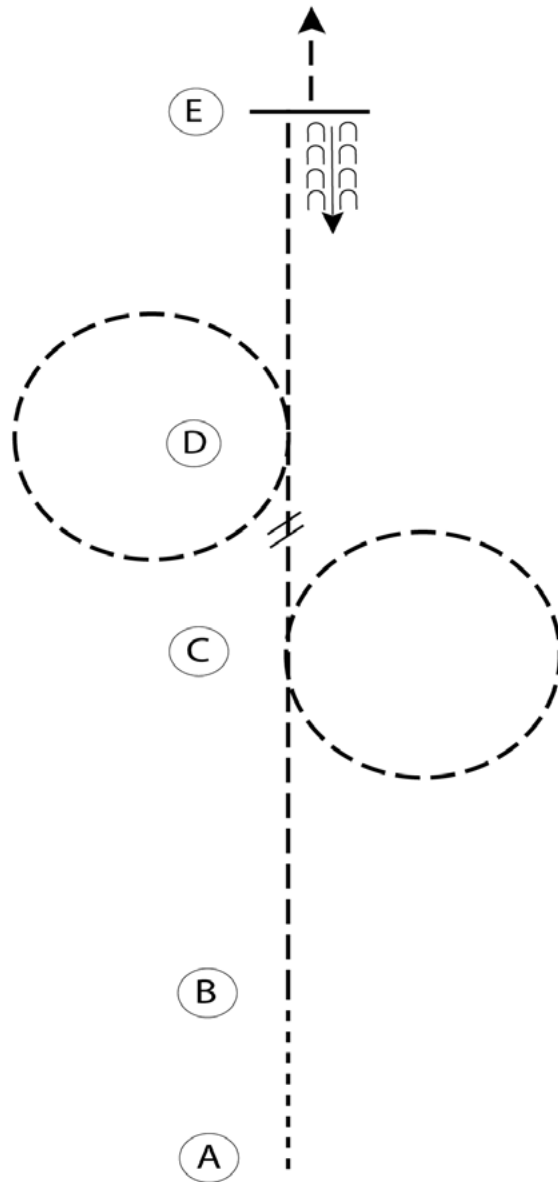

1. Walk from A to B.
2. At B, posting trot left diagonal.
3. At C, trot a circle to the right.
4. Change diagonals between C and D.
5. Trot a circle to the left around D.
6. Trot to E, stop and back.
7. Sitting trot to the exit.

Walk	-----
Trot	- - - - -
Extended Trot	-----
Canter	-----
Leg Yield	
Lead Change	///
Back	←←←←← →→→→→
Marker	(B)
Sidepass	←---←
Hand Gallop	-----

# Hunt Seat Equitation Junior Pattern 1

Produced by Horse Show Patterns.com

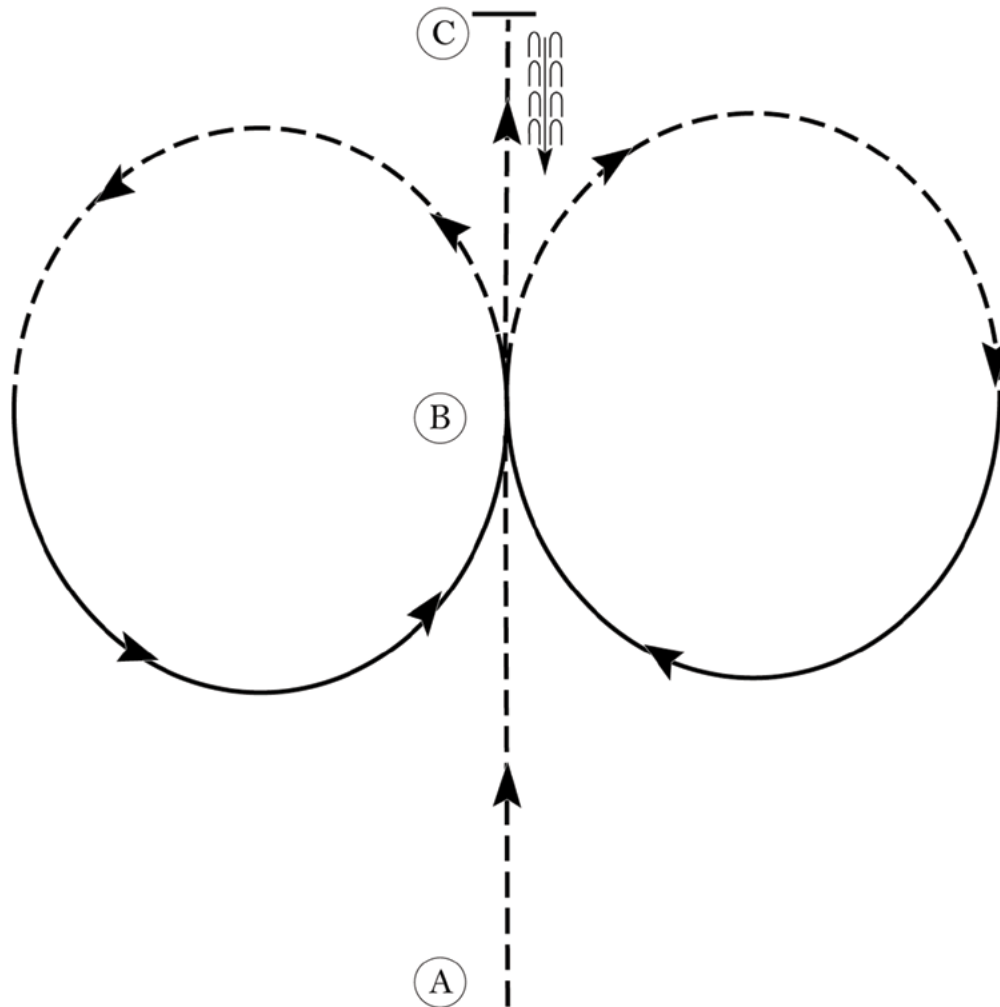

1. Sitting trot A to B.
2. At B posting trot on the left diagonal in a half circle.
3. Canter on the right lead back to B.
4. Posting trot on the right diagonal in a half circle.
5. Canter on the left lead back to B
6. Sitting trot to C.
7. Stop at C and back approximately one horse length.

Exit at a sitting trot.

Walk	-----
Trot	- - - - -
Extended Trot	— — — — —
Canter	—————
Leg Yield	
Lead Change	↘
Back	←←←←← →→→→→
Marker	(B)
Sidepass	←←←←←
Hand Gallop	—————

# Hunt Seat Equitation Junior Pattern 2

Produced by Horse Show Patterns.com

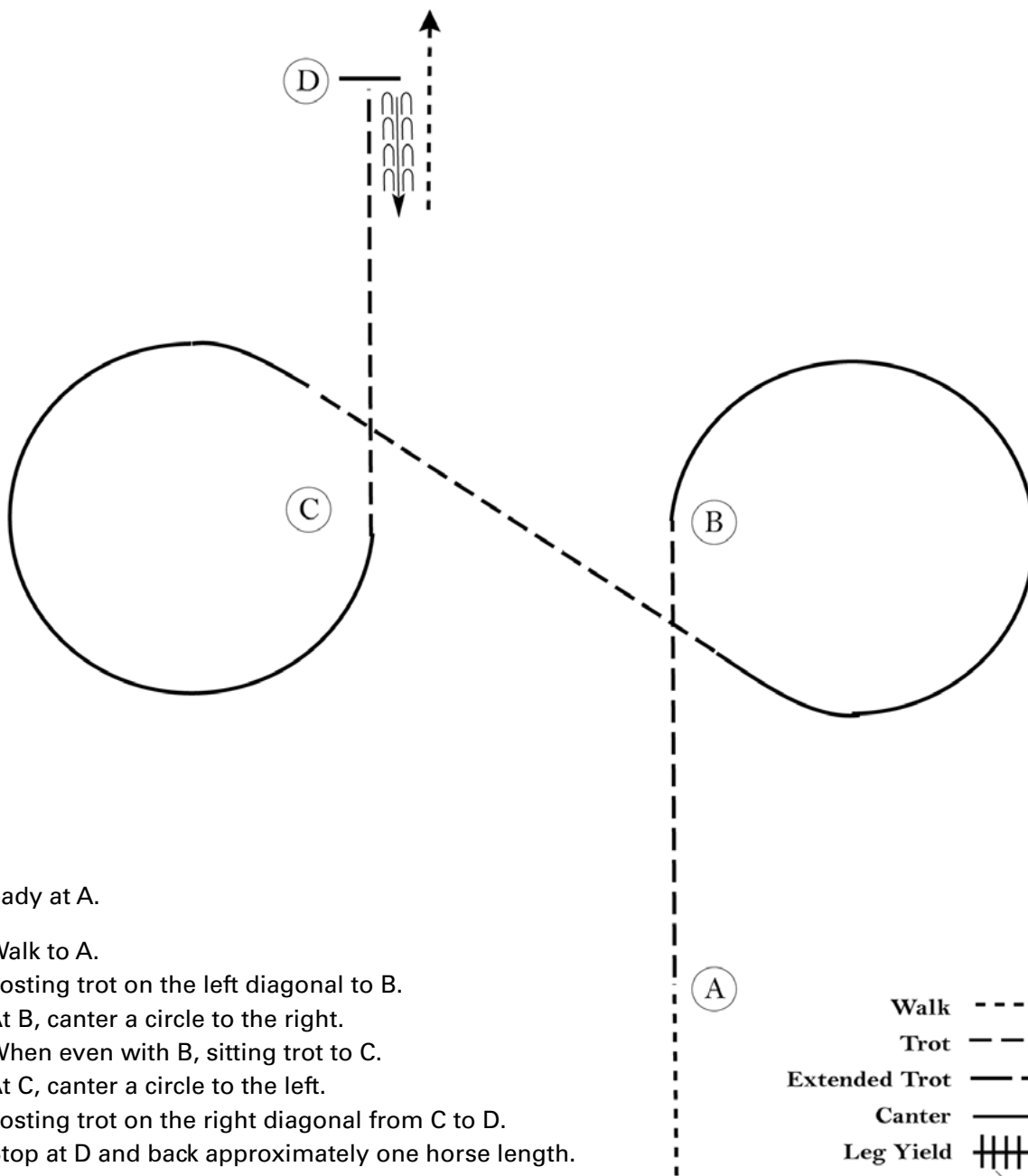

Be ready at A.

1. Walk to A.
2. Posting trot on the left diagonal to B.
3. At B, canter a circle to the right.
4. When even with B, sitting trot to C.
5. At C, canter a circle to the left.
6. Posting trot on the right diagonal from C to D.
7. Stop at D and back approximately one horse length.

Exit at a walk.

Follow the instructions of your ring steward.

Walk	-----
Trot	- - - - -
Extended Trot	— — — — —
Canter	—————
Leg Yield	
Lead Change	↙
Back	← 3 3 3 3
Marker	(B)
Sidepass	← — — — — →
Hand Gallop	———

# Hunt Seat Equitation Junior Pattern 3

Produced by Horse Show Patterns.com

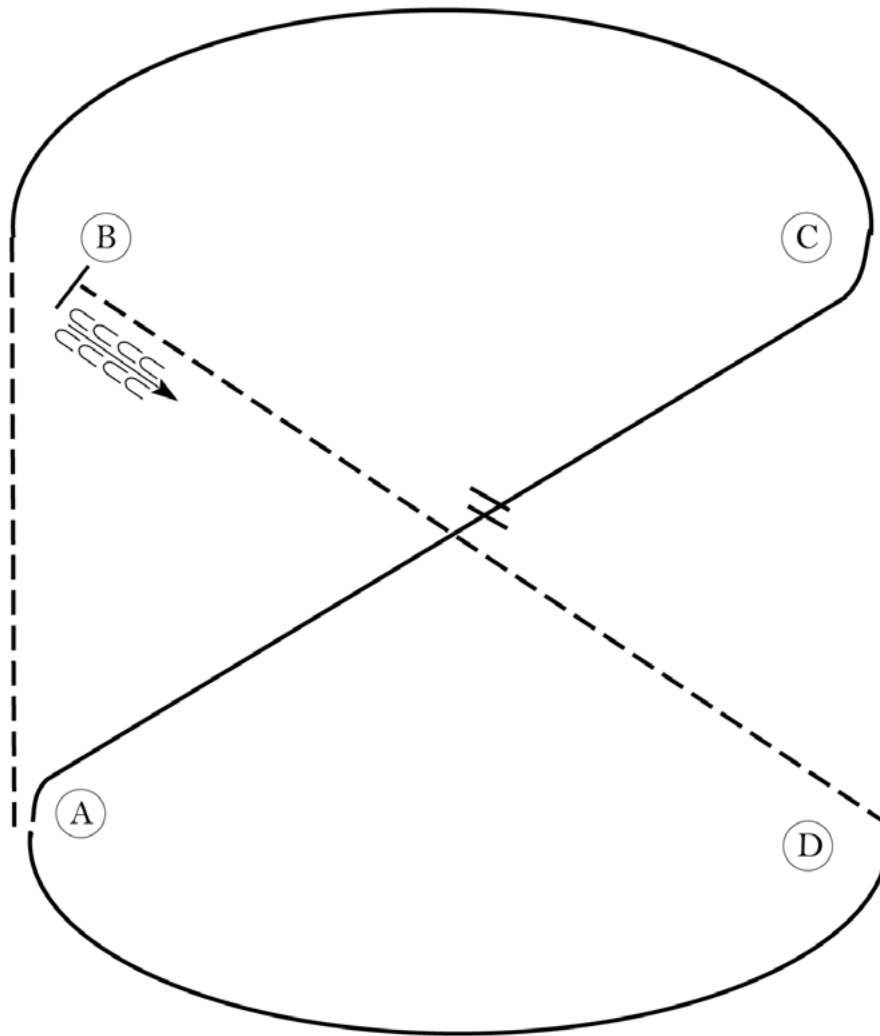

Be ready before A.

1. Trot on the left diagonal to B.
2. Canter on the right lead to and around C and half way to A.
3. Perform a simple lead change between C and A.
4. Canter around A and to D.
5. Trot on the right diagonal from D to B.
6. Stop at B and back approximately one horse length

Walk off and follow the directions of your ring steward.

<b>Walk</b>	-----
<b>Trot</b>	- - - - -
<b>Extended Trot</b>	- - - - -
<b>Canter</b>	—————
<b>Lead Change</b>	
<b>Back</b>	
<b>Marker</b>	(B)
<b>Hand Gallop</b>	—————

# Saddle Seat Equitation Junior Pattern 1

Produced by Horse Show Patterns.com

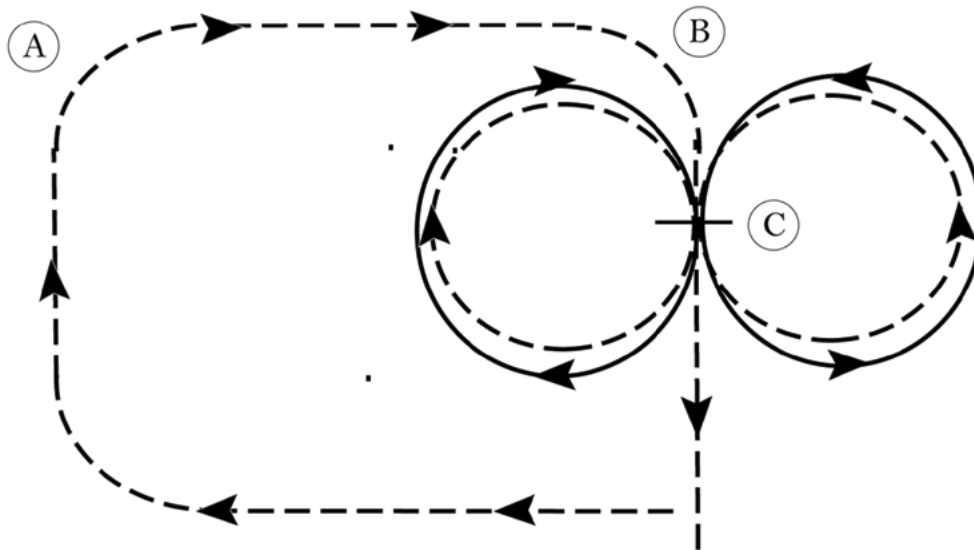

1. Trot into the arena to the left to the midpoint of the straightaway (A).
2. Make a right turn and proceed to the center of the arena (B).
3. Make a right turn and continue to a point 1/4 of the way down the arena (C). Stop briefly.
4. Canter a figure eight – first circle to the right and the second circle left. Stop briefly.
5. Trot a figure eight – the first circle left and the second circle right. Trot to exit.

<b>Walk</b>	-----
<b>Trot</b>	- - - - -
<b>Extended Trot</b>	— — — —
<b>Canter</b>	—————
<b>Lead Change</b>	
<b>Back</b>	
<b>Reference Point</b>	ⓑ

The workout has been completed –ThankYou.

## Saddle Seat Equitation Junior Pattern 2

Produced by Horse Show Patterns.com

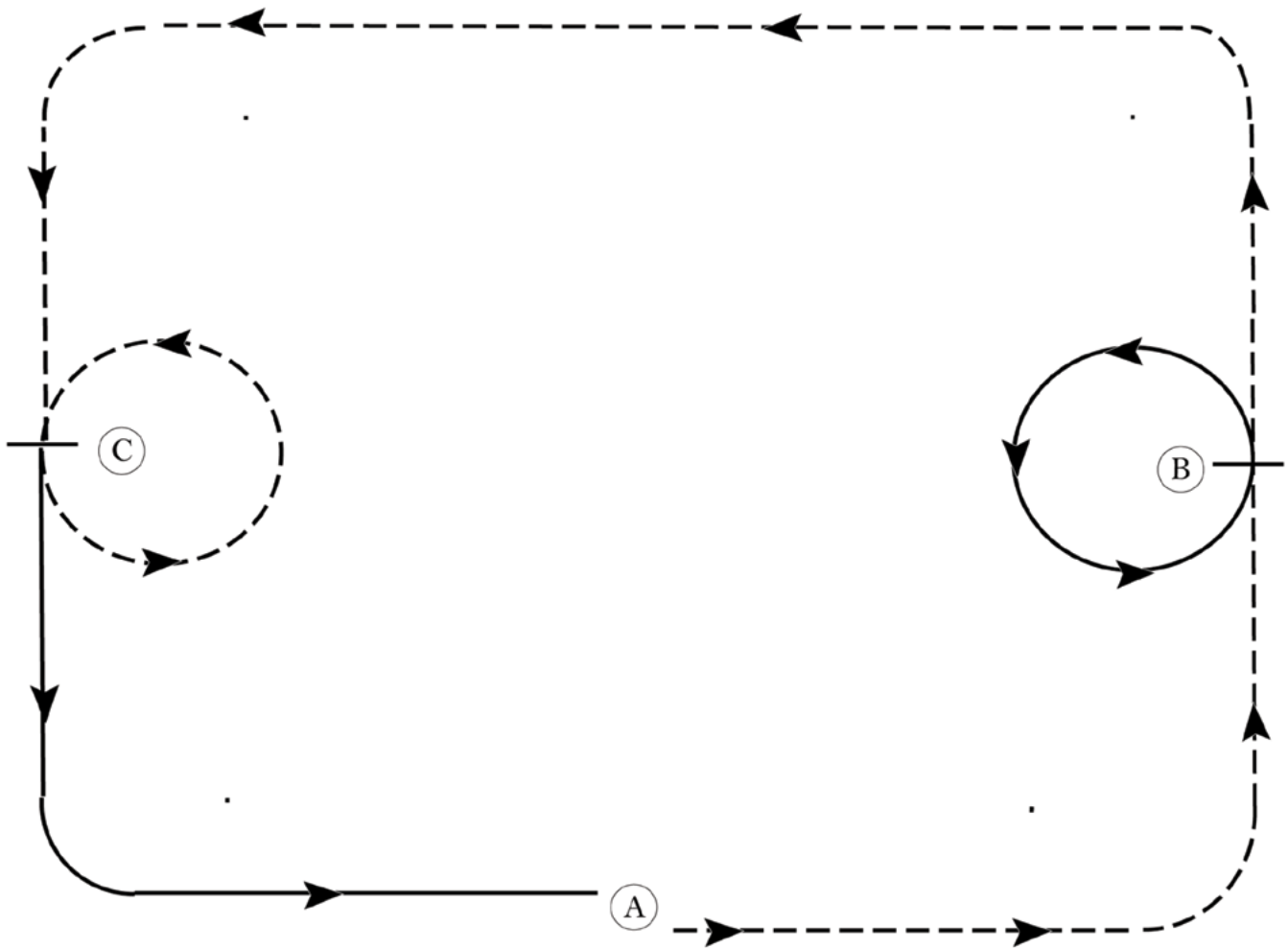

Begin at the mid-point of the in gate end of the arena (A).

1. Trot to the right, around the curve and to the mid-point of the straightaway (B). Stop briefly.
2. Canter a circle to the left on the left lead.
3. Trot on the rail to the mid-point of the opposite straightaway (C)
4. Circle to the left at the trot. Stop briefly.
5. Canter on the left lead down the straightaway, around the corner and to the mid-point of the straightaway (A).

<b>Walk</b>	-----
<b>Trot</b>	- - - - -
<b>Extended Trot</b>	— — — — —
<b>Canter</b>	—————
<b>Lead Change</b>	
<b>Back</b>	
<b>Reference Point</b>	(B)

The workout has been completed -Thank You.



# Saddle Seat Equitation Junior Pattern 3

Produced by Horse Show Patterns.com

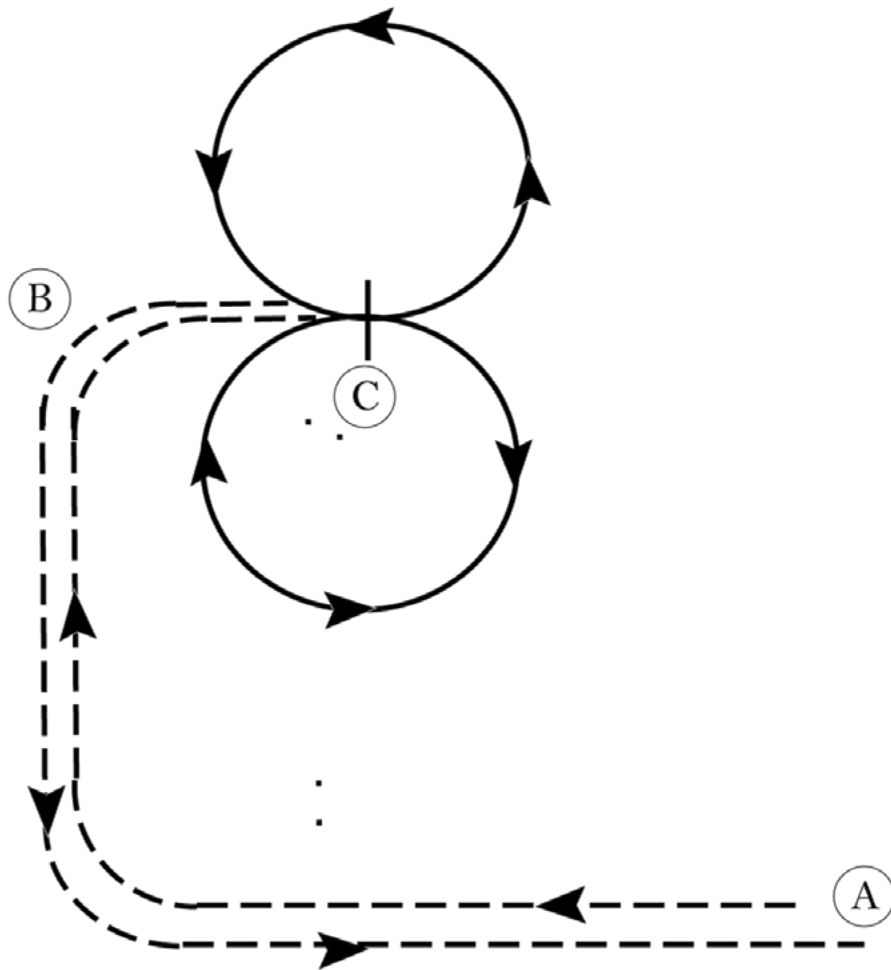

Begin at the mid-point of the in gate end of the arena (A).

1. Trot to the left, around the curve and to the mid-point of the straightaway (B).
2. Without halting, make a turn to the right, and continue 1/4 of the way across the arena (C). Stop briefly.
3. Canter a figure eight, the first circle clockwise and the second circle counter clockwise. Stop briefly (C).
4. Reverse and trot to the rail (B). Turn left and continue to the end of the straightway, around the curve and to the midpoint of the straightaway (A).

<b>Walk</b>	-----
<b>Trot</b>	- - - - -
<b>Extended Trot</b>	— — — — —
<b>Canter</b>	—————
<b>Lead Change</b>	
<b>Back</b>	
<b>Reference Point</b>	(B)

The workout has been completed - Thank You.

# Stock Seat Equitation Beginner Pattern 1

Produced by Horse Show Patterns.com

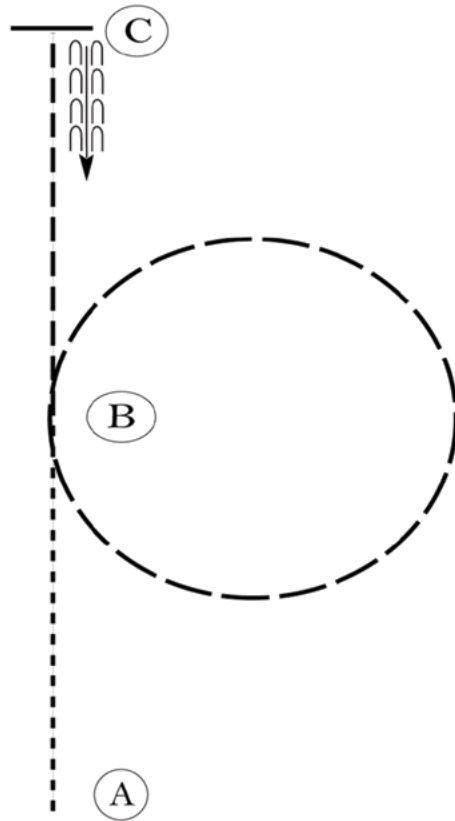

Be ready at A.

1. Walk from A to B.
2. Perform an extended jog circle to the right at B.
3. Slow to a jog at B. Jog to C.
4. Stop at C and back approximately one horse length.

Follow instructions of your ring steward.

<b>Walk</b>	-----
<b>Jog</b>	-----
<b>Extended Jog</b>	-----
<b>Lope</b>	—————
<b>Leg Yield</b>	
<b>Lead Change</b>	— / —
<b>Back</b>	← — — — — — — — — —
<b>Marker</b>	⊙ B
<b>Sidepass</b>	← — — — — ←

# Stock Seat Equitation Beginner Pattern 2

Produced by Horse Show Patterns.com

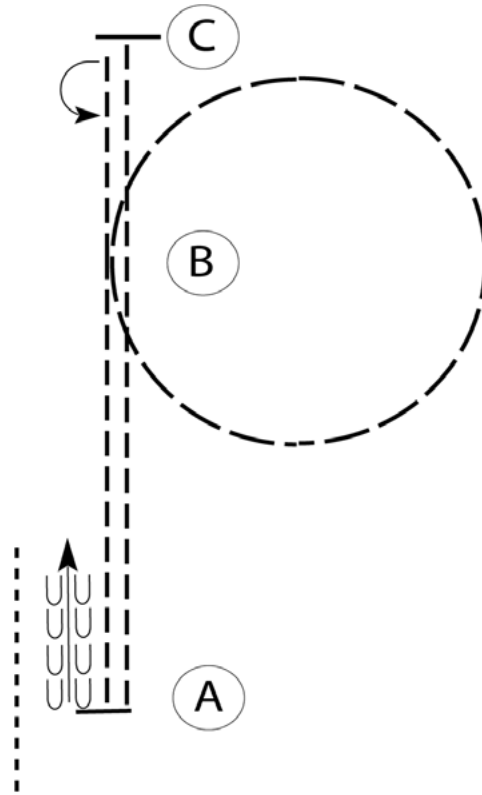

Be ready at A.

1. Jog from A to C.
2. Stop at C and perform a 180 degree turn to the left.
3. Jog to B.
4. Extended jog circle to the left.
5. Jog from B to A.
6. Stop at A and back approximately one horse length.
7. Walk to A and exit at a walk.

Follow the instructions of your ring steward.

<b>Walk</b>	-----
<b>Jog</b>	-----
<b>Extended Jog</b>	-----
<b>Lope</b>	—————
<b>Leg Yield</b>	
<b>Lead Change</b>	↘
<b>Back</b>	← 3 3 3 3 3 3
<b>Marker</b>	⊙ B
<b>Sidepass</b>	←-----→

# Stock Seat Equitation Beginner Pattern 3

Produced by Horse Show Patterns.com

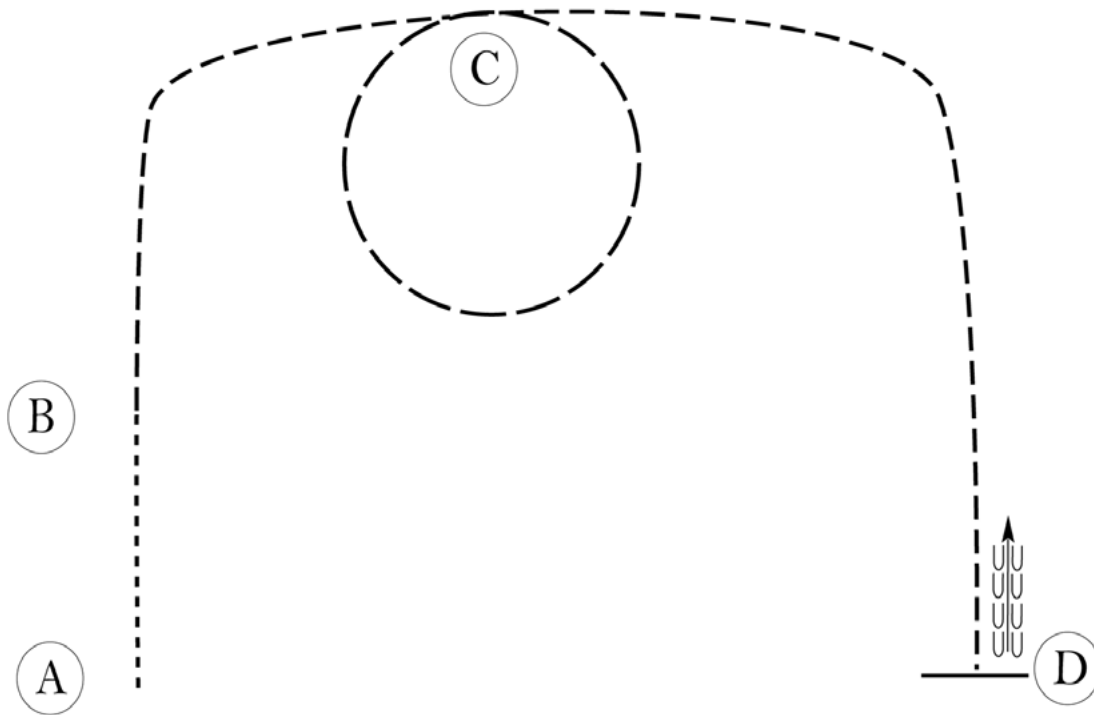

Be ready at A.

1. Walk to B.
2. Jog from B to C.
3. Perform an extended jog circle to the right at C.
4. Slow to a jog and jog to D.
5. Stop at D and back approximately one horse length.

Follow the instructions of your ring steward.

<b>Walk</b>	-----
<b>Jog</b>	-----
<b>Extended Jog</b>	-----
<b>Lope</b>	-----
<b>Leg Yield</b>	
<b>Lead Change</b>	— / —
<b>Back</b>	← — — — — —
<b>Marker</b>	⊙ B
<b>Sidepass</b>	← — — — — — →

# Stock Seat Equitation Junior Pattern 1

Produced by Horse Show Patterns.com

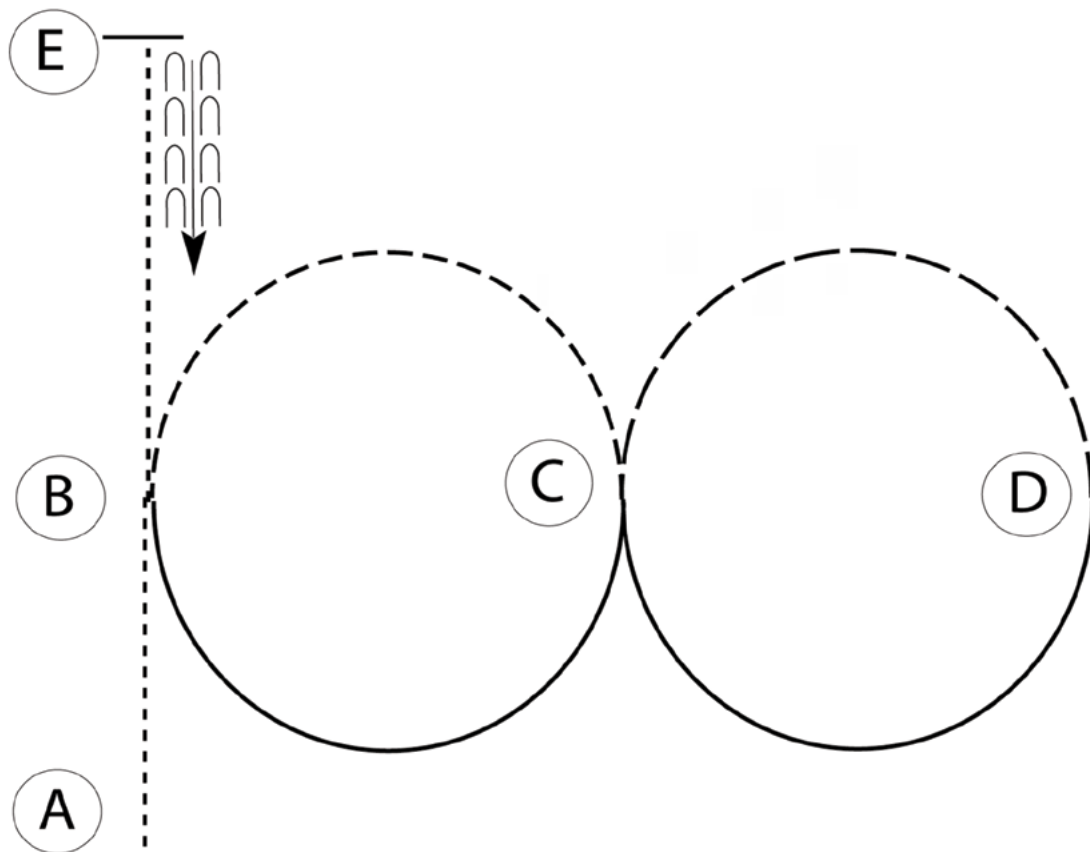

Be ready at A.

1. Walk to A to B.
2. Jog a half circle to C.
3. Lope a half circle on the left lead to D.
4. Extend the jog in a half circle to C.
5. Lope a half circle on the right lead to B.
6. Walk to E.
7. Stop at E and back approximately one horse length.

Follow the instructions of your ring steward.

<b>Walk</b>	.....
<b>Jog</b>	-----
<b>Extended Jog</b>	-----
<b>Lope</b>	—————
<b>Lead Change</b>	
<b>Back</b>	
<b>Marker</b>	(B)

# Stock Seat Equitation Junior Pattern 2

Produced by Horse Show Patterns.com

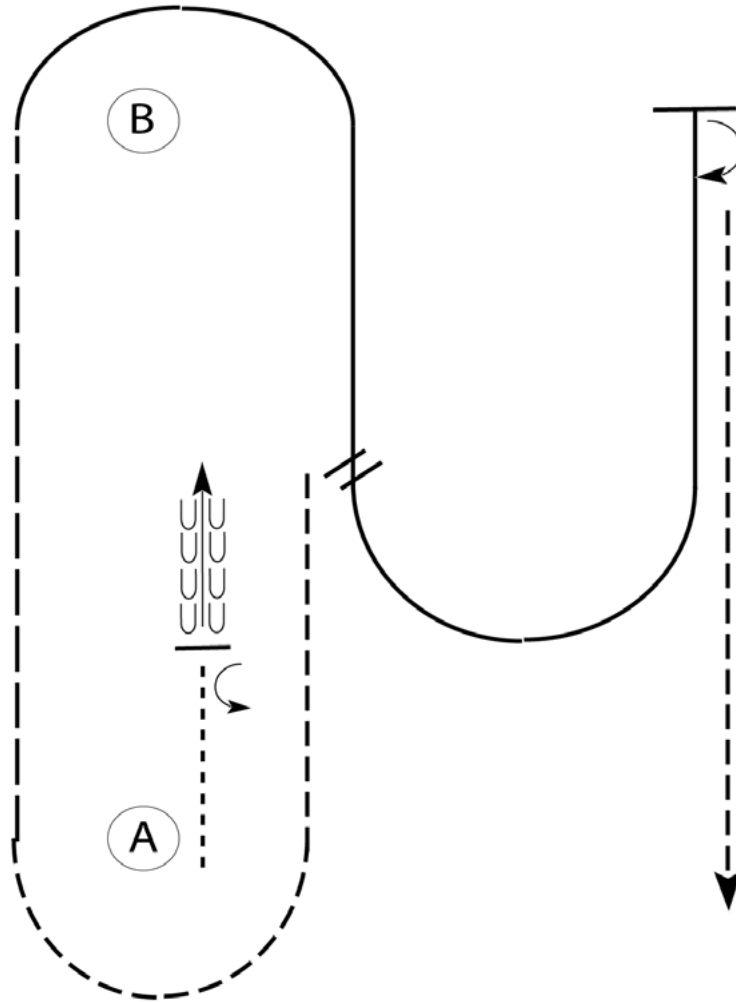

Be ready at A.

1. Walk approximately two horse lengths forward. Stop and perform a 1/2 turn left.
2. Back approximately two horse lengths then jog to and around A.
3. Extend the jog to B.
4. Right lead lope around B and halfway to A.
5. Perform a simple lead change and lope a half circle until even with B.
6. Stop and perform a 180 degree turn to the right and jog to finish.

<b>Walk</b>	-----
<b>Jog</b>	-----
<b>Extended Jog</b>	-----
<b>Lope</b>	-----
<b>Lead Change</b>	
<b>Back</b>	
<b>Marker</b>	

# Stock Seat Equitation Junior Pattern 3

Produced by Horse Show Patterns.com

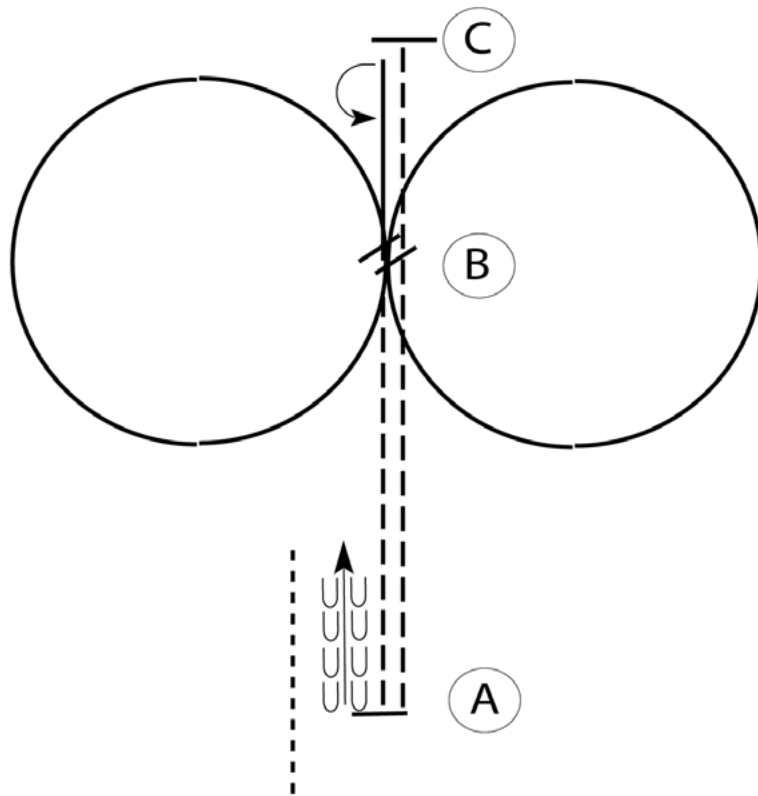

Be ready at A.

1. Jog from A to C.
2. Stop at C and perform a 180 degree turn to the left.
3. Lope on the left lead to B.
4. Lope a circle to the left.
5. Perform a simple lead change at B.
6. Lope a circle to the right.
7. Jog from B to A.
8. Stop at A and back approximately one horse length.
9. Walk to A and exit at a walk.

Follow the directions of your ring steward.

<b>Walk</b>	-----
<b>Jog</b>	-----
<b>Extended Jog</b>	-----
<b>Lope</b>	—————
<b>Leg Yield</b>	
<b>Lead Change</b>	—/—
<b>Back</b>	← ↪↪↪ ↪↪↪
<b>Marker</b>	Ⓚ
<b>Sidepass</b>	←-----→

## Reining Pattern 1

Produced by *Horse Show Patterns.com*

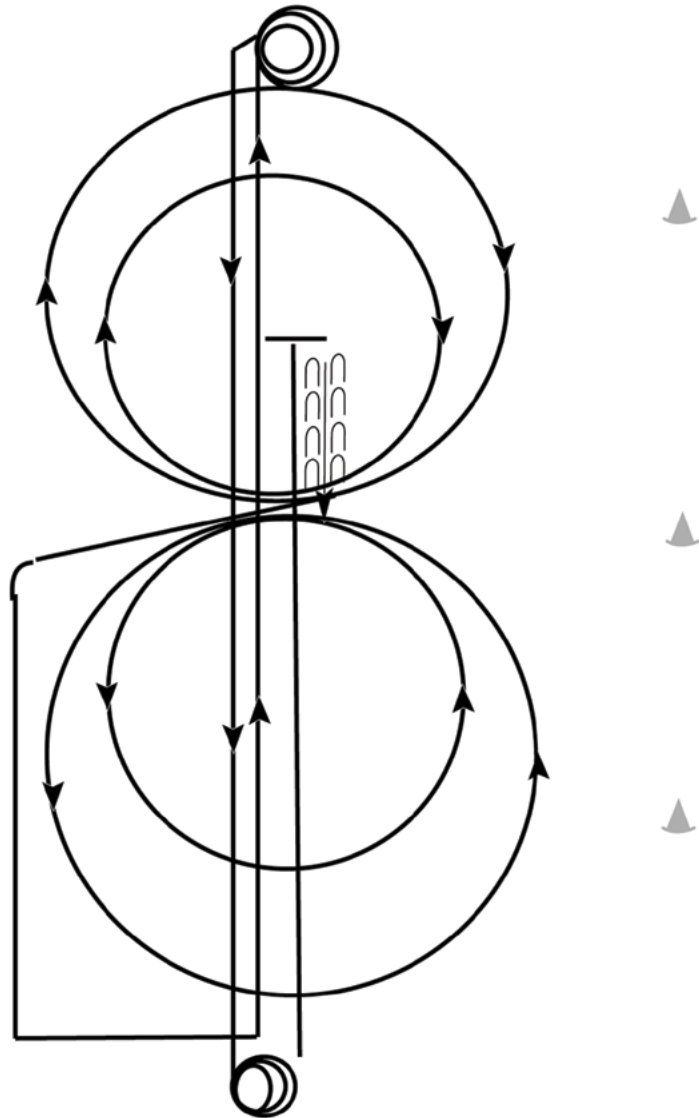

1. Start at end of arena.
2. Run past the center marker and stop.
3. Back up at least 10 feet.
4. Complete 1/4 turn to the left.
5. Complete 2 circles to the left, the first one large and fast and the second small and slow. Change leads at the center of the arena.
6. Complete two circles to the right, the first one small and slow, the second large and fast. Change leads at the center of the arena.
7. Continue around the end of the arena without breaking gait or changing leads, run down center of arena past end marker, come to a square sliding stop.
8. Complete 3 1/2 spins to the right.
9. Run down center of arena past end marker and come to a square sliding stop.
10. Complete 3 1/2 spins to the left.
11. Hesistate to complete pattern.



## Reining Pattern 2

Produced by Horse Show Patterns.com

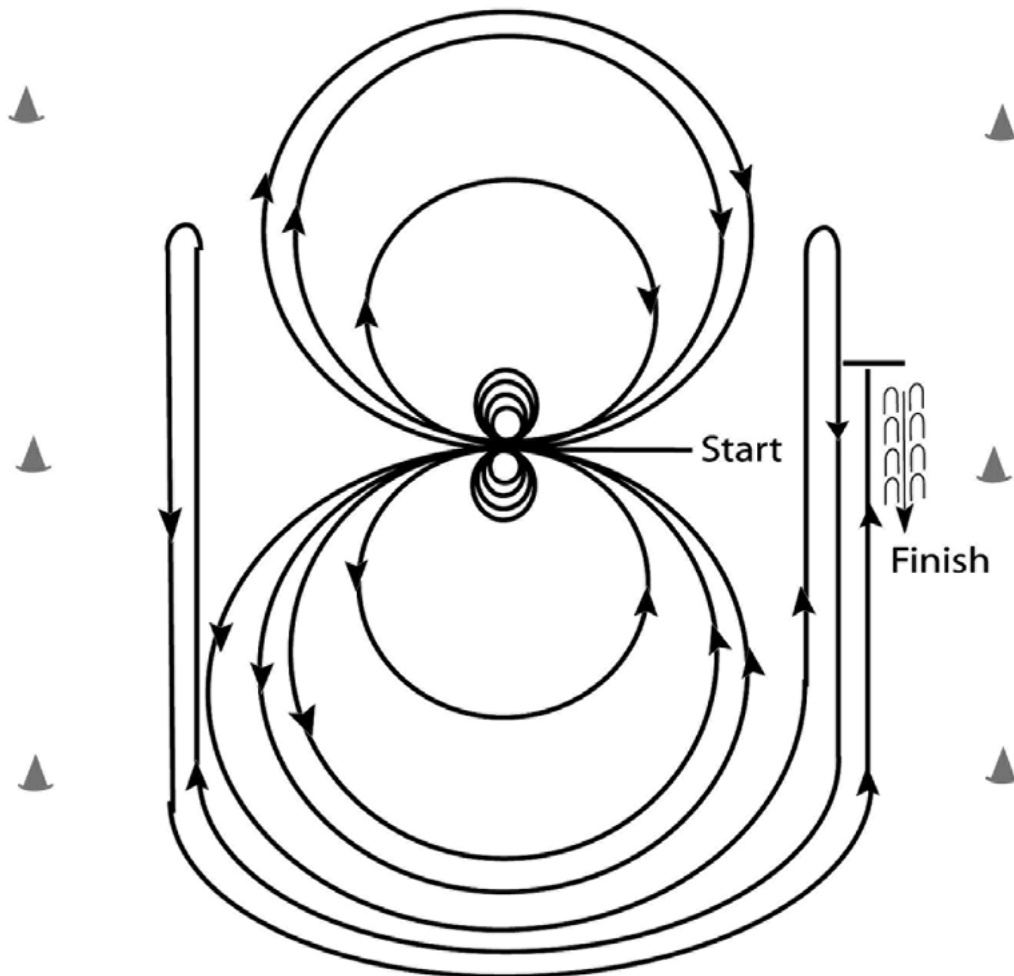

Horse must walk or stop prior to starting pattern. Beginning at the center of the arena facing the left wall or fence

1. Complete four spins to the right.
2. Complete four spins to the left. Hesitate.
3. Beginning on the left hand lead, complete three circles to the left: the first two circles large and face; the third circle small and slow. Change leads at the center of the arena.
4. Complete three circles to the right: the first two circles large and fast; the third circle small and slow. Change leads at the center of the arena.
5. Begin a large, fast circle to the left but do not close this circle. Run up the right side of the arena past the center marker and do a right rollback at least twenty feet (6.09m) from the wall or fence – no hesitation.
6. Continue back around previous circle but do not close this circle. Run up the left side of the arena past the center marker and do a left rollback at least twenty feet (6.09m) from the wall or fence – no hesitation.
7. Continue back around previous circle but do not close this circle. Run up the right side of the arena past the center marker and do a sliding stop at least twenty feet (6.09m) from the wall or fence. Back up at least ten feet (3m). Hesitate to demonstrate the completion of the pattern.

Rider may drop bridle to the designated judge.

## Reining Pattern 3

Produced by Horse Show Patterns.com

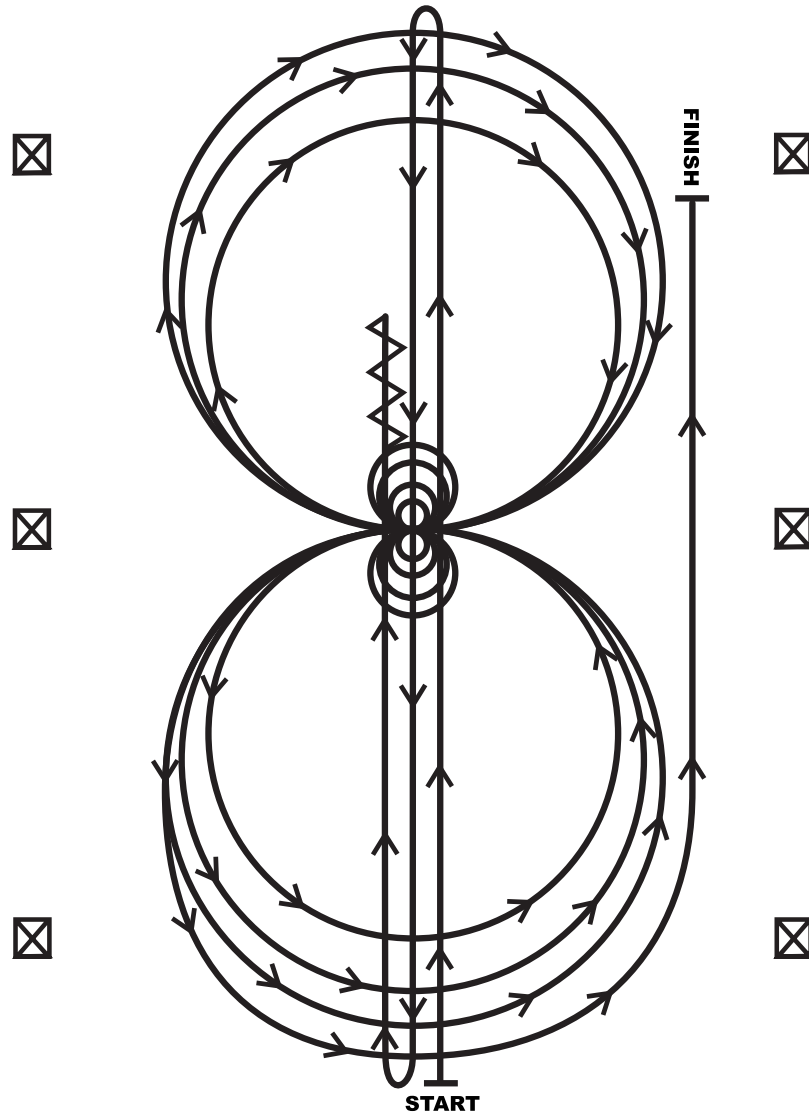

**Mandatory Marker along Fence or Wall:** The judge shall indicate with markers on arena fence or wall the center of pattern.

Ride pattern as follows:

1. Run at speed to the far end of the arena past the endmarker and do a left rollback.
2. Run to the opposite end of the arena past the endmarker and do a rollback.
3. Run past the center marker and do a sliding stop. Back up to the center of the arena or at least ten feet (three meters.) Hesitate.
4. Complete four spins to the right. Hesitate.
5. Complete four and one quarter spins to the left so that the horse is facing the wall or fence. Hesitate.
6. Beginning on the left lead complete three circles to the left: the first circle large and fast; the second circle small and slow; the third circle large and fast. Change leads at the center of the arena.
7. Complete three circles to the right: the first circle large and fast; the second circle small and slow; the third circle large and fast. Change leads at the center of the arena.
8. Begin a large circle to the left but do not close this circle. Run straight up the right side of the arena past the center marker and do a sliding stop at least twenty feet (six meters) from wall or fence. Hesitate to demonstrate the completion of pattern.

# Ranch Riding Junior/Senior Pattern 1

Produced by Horse Show Patterns.com

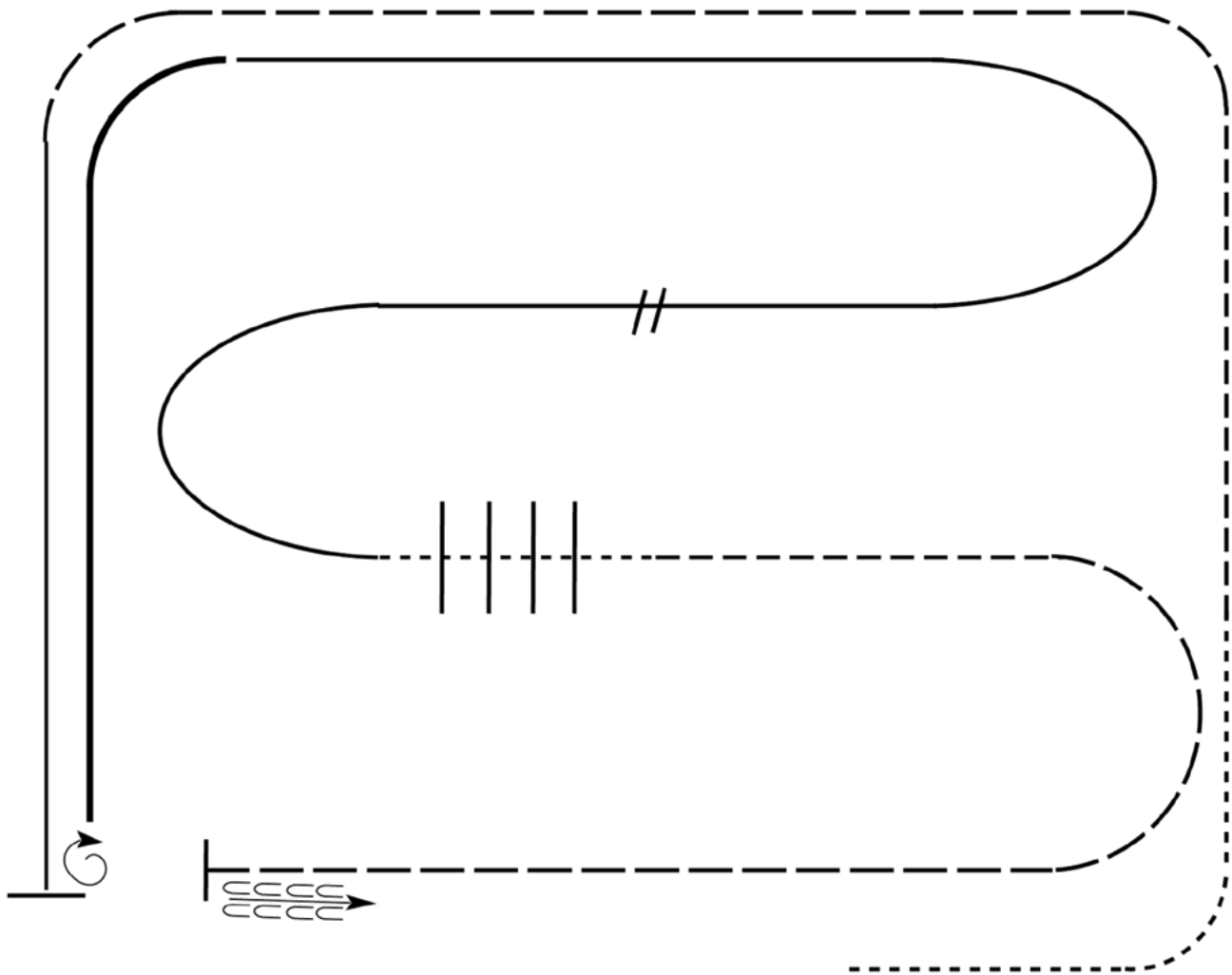

1. Walk.
2. Trot.
3. Extended trot.
4. Left lead lope.
5. Stop, 1 1/2 turn right.
6. Extended lope.
7. Collect to working lope-right lead.
8. Change leads (simple or flying).
9. Walk.
10. Walk over logs.
11. Trot
12. Extended trot.
13. Stop and back.

<b>Walk</b>	-----
<b>Jog</b>	- - - - -
<b>Extended Jog</b>	_____
<b>Lope</b>	—————
<b>Lead Change</b>	
<b>Back</b>	
<b>Marker</b>	Ⓚ

# Ranch Riding Junior/Senior Pattern 2

Produced by Horse Show Patterns.com

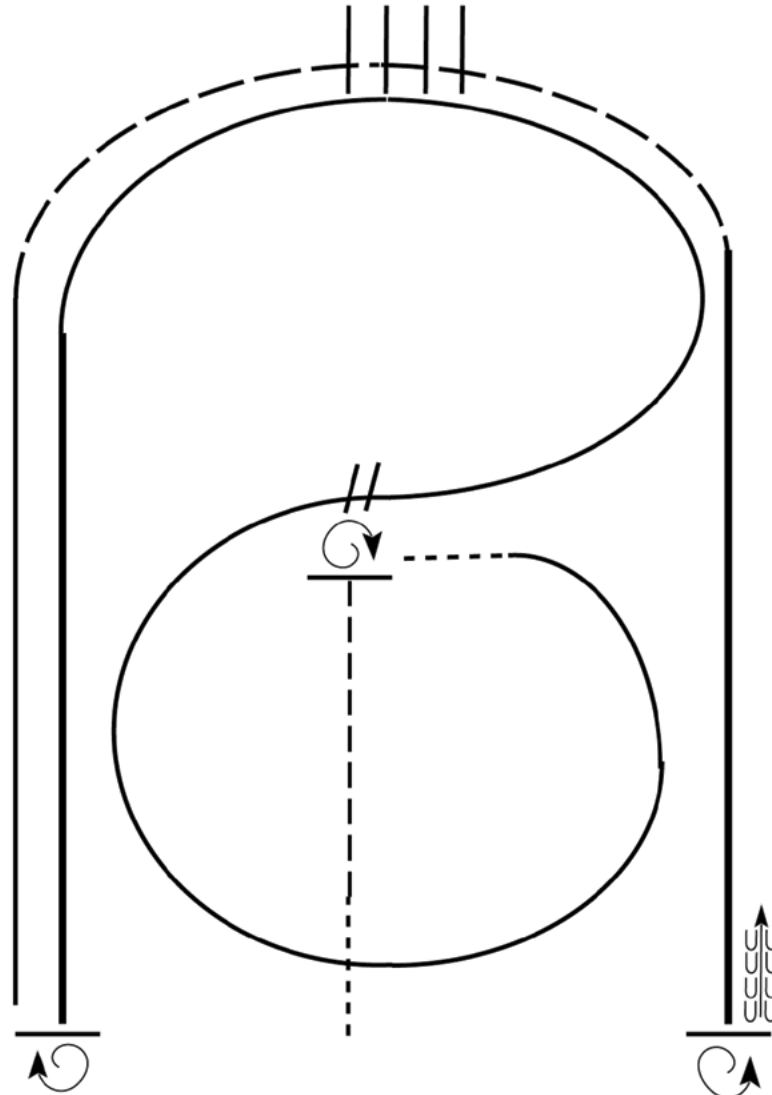

1. Walk.
2. Jog.
3. Stop, do a 1 1/4 turn to the right.
4. Walk. Then, lope small circle on the right lead.
5. Change leads, (simple or flying) lope left lead around end of the arena.
6. Extend the lope on the left lead.
7. Stop, do a 2 1/2 turns right.
8. Lope straight on the right lead.
9. Extend the jog around end of the arena across poles/logs.
10. Extend the lope on right lead.
11. Stop, do a 2 turn left.
12. Back.

<b>Walk</b>	-----
<b>Jog</b>	- - - - -
<b>Extended Jog</b>	- - - - -
<b>Lope</b>	—————
<b>Lead Change</b>	
<b>Back</b>	
<b>Marker</b>	(B)

# Ranch Riding Junior/Senior Pattern 3

Produced by Horse Show Patterns.com

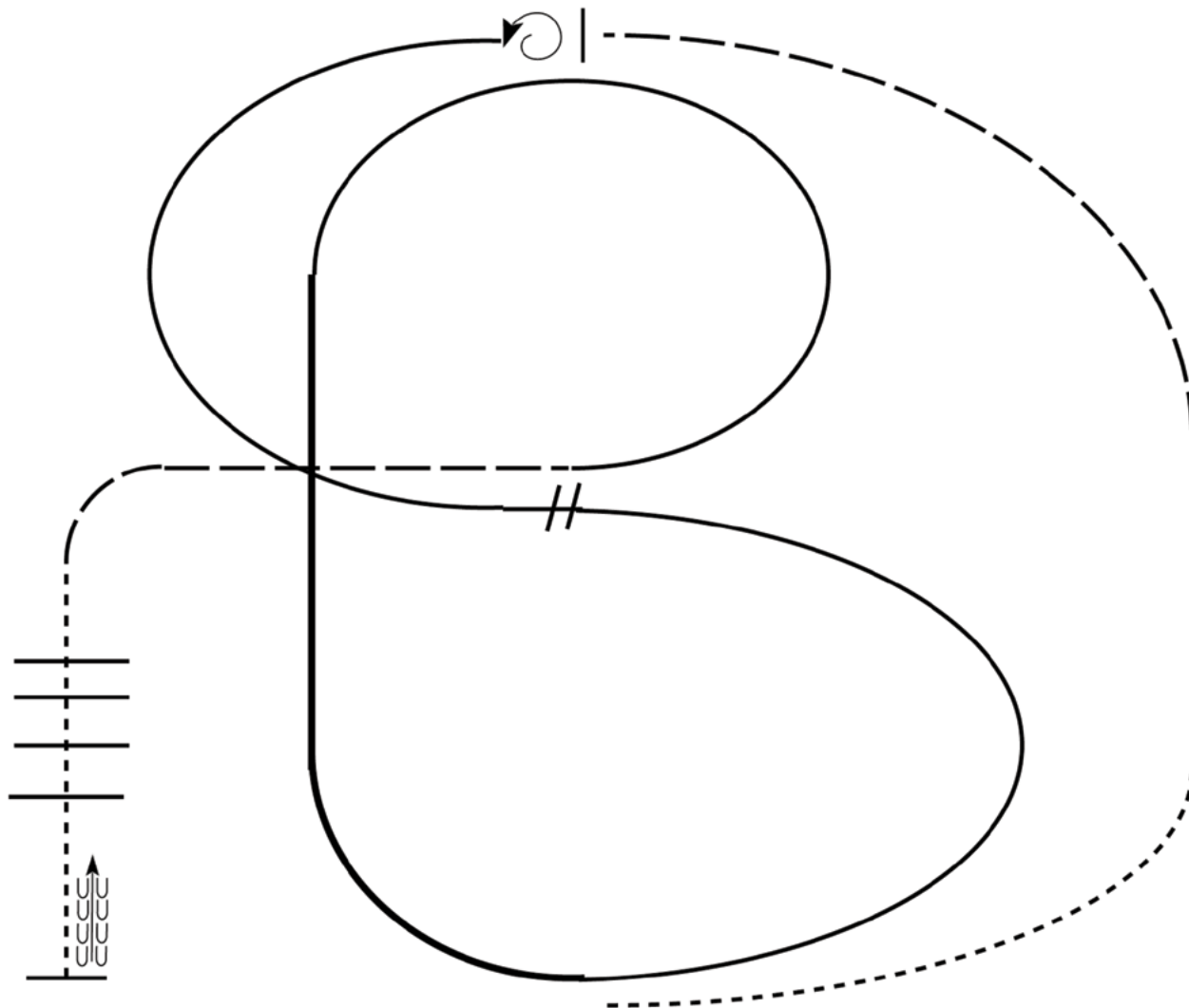

1. Walk.
2. Trot.
3. Extend the trot, at the top of the arena, stop.
4. 360 degree turn to the left.
5. Left lead 1/2 circle, lope to the center.
6. Change leads (simple or flying).
7. Right lead 1/2 circle.
8. Extended lope up the long side of the arena (right lead).
9. Collect back to a lope around the top of the arena and back to center.
10. Break down to an extended trot.
11. Walk over poles.
12. Stop and back.

<b>Walk</b>	-----
<b>Jog</b>	-----
<b>Extended Jog</b>	-----
<b>Lope</b>	-----
<b>Lead Change</b>	
<b>Back</b>	
<b>Marker</b>	



# Examples of Hunter over Fences Courses

